



EDAC 222-02 AUTO ALARM DIALLER USER MANUAL

All specifications are subject to change at any time without notice.

For Firmware from V2.5.1

© EDAC Electronics Ltd 2002

Document Version 1.3

www.edacelectronics.com

INTRODUCTION	1
NEW FEATURES	2
SPECIFICATIONS	3
INSTALLATION.....	5
Installation Requirements.....	5
Jumper Settings	8
HOW THE EDAC 222-02 WORKS – RUN MODE.....	9
Displays.....	9
Cancelling Alarm Notification Calls	11
EXPLANATION OF PROMPTS – PROGRAMMING MODE	12
GETTING STARTED QUICKLY - EXAMPLE.....	13
Entering Programming Mode.....	13
Programming Telephone Numbers.....	13
Recording Input Trigger one Voice Message.....	14
Replaying the Recorded Message	14
Exit to Run Mode.....	14
Testing the EDAC 222-02.....	15
HOW TO PROGRAM THE EDAC 222-02	16
Introduction	16
Definition of Terms Used.....	16
<i>The  Key - Program Checking</i>	<i>16</i>
Fixing Data Entry Errors	17
Programming the Functions for Individual Alarm Inputs	17
Entering Programming Mode.....	18
What to do if you Forget your PIN Number.....	18
Exit to RUN Mode	18
Restore Factory Defaults	19
<i>Function F0* Recording Voice Messages</i>	<i>20</i>
<i>Function F00 Modify PIN Number.....</i>	<i>22</i>
<i>Function F02 Call Progress.....</i>	<i>22</i>
<i>Function F03 Cancel Options When Making a Call to the EDAC 222-02.....</i>	<i>23</i>
<i>Function F04 Answer Incoming Calls When any Input Active.....</i>	<i>24</i>
<i>Function F05 Answer Incoming Calls When all Inputs are Cancelled</i>	<i>24</i>
<i>Function F06 Answer Incoming Calls When no Inputs Active (Idle)</i>	<i>25</i>
<i>Function F07 Call List Priority & Rosters.....</i>	<i>26</i>
<i>Function F09 Trigger/Dial Time.....</i>	<i>27</i>
<i>Function F10 Programming Your Pager Messages.....</i>	<i>27</i>
<i>Function F11 Programming Your Telephone/Pager Numbers</i>	<i>28</i>
<i>Function F51 Setting Inputs to Trigger or Report.....</i>	<i>30</i>
<i>Function F52 Physical Input Trigger Configuration</i>	<i>31</i>
<i>Function F53 Wait Time Between Calls.....</i>	<i>32</i>
<i>Function F54 Pager Delay Time.....</i>	<i>32</i>
<i>Function F55 Message Play Time.....</i>	<i>33</i>
<i>Function F56 Call Counter</i>	<i>34</i>
MISCELLANEOUS FUNCTIONS.....	35
<i>Function F96 Trigger/dial Mode.....</i>	<i>35</i>
USING A PAGER WITH THE EDAC 222-02.....	36
Numeric Pager.....	36
ADVANCED FEATURES	37
Outputs.....	37
FREQUENTLY ASKED QUESTIONS.....	38
COMPLIANCE NOTES.....	40
NOTICE TO AUSTRALIAN USERS	40

NOTICE TO NEW ZEALAND USERS40

GLOSSARY41

WARRANTY42

INTERNATIONAL CONTACT DETAILS.....43

INTRODUCTION

The EDAC 222-02 is a cost-effective, auto reporting dialler designed for domestic and small-business security monitoring, or for general purpose monitoring. The EDAC 222-02 is an effective tool for alerting the user to events such as faults or changes in equipment state. It is physically compact, consumes little power and can be installed very quickly. Its ease of programming combined with simple installation make it highly attractive and cost effective in monitoring applications.

The EDAC 222-02 is activated by a contact closure, or opening, which results in the start of a user defined dialling sequence, followed by the transmission of either an 8-second voice message or 20 character pager message.

When an event triggers the auto-dialler, the EDAC 222-02 will make an alarm notification call. The EDAC 222-02 will pick up the phone line and call a list of people via telephone, cell phone or pager. The EDAC 222-02 speaks a pre-recorded voice message announcing the problem.

Upon receipt of an alarm call you may reset the EDAC 222-02 by simply pressing a numeric digit on your telephone keypad or by entering a user-defined PIN number. This will stop the unit making further alarm notification calls. Alternatively, the EDAC 222-02 may be interrogated by calling into it and listening to the voice message. This provides the opportunity to cancel/acknowledge the alarm Inputs via the telephone keypad. This option would normally be used when the EDAC 222-02 is operating in conjunction with a pager.

Once the EDAC 222-02 is in a cancelled state, it will suspend its dialling sequence and remain cancelled until the event that triggered the alarm has been removed (cleared). If the EDAC 222-02 does not receive acknowledgment of an alarm, it will remain in dialling mode until the event that triggered the alarm is cleared, or the user-defined call count limit is reached.

All telephone numbers, messages, and functions are user programmable via a keypad and a single character display.

The EDAC 222-02 has numerous programmable features that enable it to be a flexible telemetry monitoring tool suitable for use in any situation. If you require information about the EDAC 222-02 and how it can be used with your monitoring application, please contact your supplier. For online manuals for all EDAC products, use the EDAC web site <http://www.edacelectronics.com/support.html>.

NEW FEATURES

If you have used products from the EDAC range in the past, you may be interested in the improvements made to the new model.

I/O Status LEDs

Four LED lights have been added to the product to facilitate easy viewing of the state of the I/Os. When an input LED is on, the corresponding input is low. When an input LED is off, the corresponding input is in a high state. When an output LED is off the corresponding output is on, and when an output LED is on the corresponding output is off.

Earth Discharge Circuit

The EDAC 222-02 now has a separate Earth Discharge Circuit, which is used to protect the EDAC 222-02 and any attached equipment from lightning strikes and other external high voltage transients, which may travel down the telephone line. The Earth Discharge Point is located on the front right PCB screw.

NOTE: *The Earth Discharge circuit **must** be connected to a switch board earth point (earth buss bar) for proper surge protection.*

Acknowledge Relay

The Acknowledge relay seen on earlier versions of the EDAC 222-02 has been removed from this version of the product. If you have a specific need for this feature please contact your distributor.

To learn more about the features and parameters available you may spend time going through the manual. If you have any questions about the product please contact your distributor.

SPECIFICATIONS

Connections

1.5 mm screw terminals are provided for all electrical connections to the EDAC 222-02.

- **Power**
 - Voltage** 12-15V DC
 - Current** 40mA idle
80-100mA active

NOTE: *Power supply must comply with Telecom PTC101 requirements.*

- **Inputs** Two, clean-contact, voltage-free trigger Inputs such as relay contacts, a float switch or a microswitch are required.



WARNING: *Applying voltage to the Inputs of the auto-dialler may damage the EDAC 222-02 and will void the product warranty.*

- **Outputs** Two Outputs are available. Open collector type. Max current 120mA.
- **Telecom Line** Two RJ11 sockets. A suitable cord can be provided compatible with the wall socket in your country. The inner two pins of the RJ11 socket are used for TIP + RING.

Mechanical

- **Dimensions** 192mm length x 110mm width x 35mm height.
- **Weight** 250gm
- **Cabinet** Aluminium base with screw on (M4 pozi-drive) aluminium lid.
- **Finish** White epoxy powder coat.
- **Mounting** 4 x 4mm mounting holes in the base of the cabinet.
- **Line in/Line out** RJ11 Modem standard (only the 2 inner pins are used as Tip + Ring).

Messages

- **Site Message** Four seconds of high-quality, user-recordable speech. The site message should clearly identify the site where the EDAC 222-02 is located.
- **Input Messages** Eight seconds of high-quality, user-recordable speech per Input. The Input messages should clearly identify the event and what action needs to be taken.
- **Acknowledged** Four seconds of high-quality, user-recordable speech to identify when message Inputs have been acknowledged.
- **Idle Message** Four seconds of high-quality, user-recordable speech to identify when the EDAC 222-02 Inputs are in an idle state.

Parameters

- **Maximum number of telephone numbers** 16, can be broken down into max of 4 lists.
- **Maximum number of digits per number** Twenty including pauses
- **Time duration of phone call (playtime)** Variable 1 - 9 minutes
- **Wait time (between each call)** Variable 0 - 9 minutes.
- **PABX access delay** Two seconds for each user inserted pause
- **Recordable message time** Up to eight seconds per Input
- **Dialling mode** DTMF (tone dialling)

Numeric Paging

Twenty-digit numeric strings can be transmitted to a Numeric Pager to identify the site and active Input trigger. Numeric paging can be configured via the EDAC 222-02 keypad.

Alarm Cancellation

Alarm notification calls can be cancelled by using a DTMF touch-tone phone. The alarm can be cancelled by pressing any numeric key on your telephone keypad or by entering a PIN, depending on which option you have selected at the time of installation and programming.

INSTALLATION

Installation Requirements

The typical wiring schematic is shown in Figure 1.

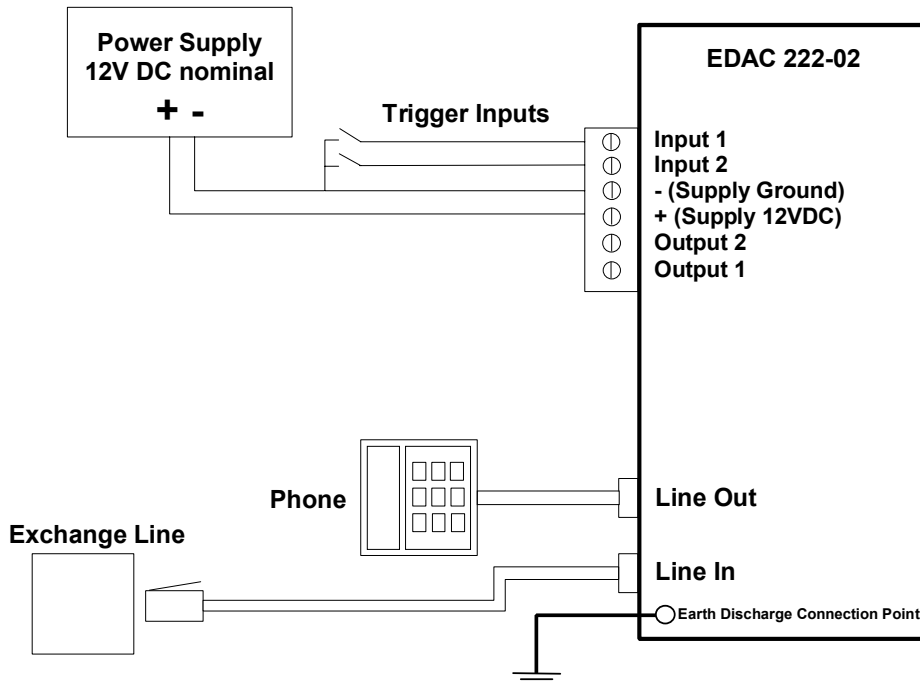

Figure 1: Typical EDAC 222-02 Installation

1. Power Supply

A DC regulated power supply complying with Telecom PTC101 is required. The DC power supply should be normally constant, between 12 and 15 volts.

2. Input Triggers

The Input trigger causes the EDAC 222-02 to commence the dialling sequence. A clean contact, voltage-free Input is required. This would normally be via an external relay. The EDAC 222-02 is configured by default for a normally open type Input. Alternatively the user can configure any of the Inputs to accept a normally closed type Input (see function **F52**).

Some examples of these types of triggers might be a relay Output, a micro-switch or a float switch.

NOTE: *The activating trigger must be installed correctly and maintained to prevent false triggering.*

3. Earth Discharge

The EDAC 222-02 has a separate Earth Discharge Circuit, which is used to protect the auto-dialler and any attached equipment from lightning strikes and other external high voltage transients, which may travel down the phone line. The Earth Discharge circuit **must** be connected to a common earth point. These are usually found at a switch board earth point (earth buss bar). The Earth Discharge should be connected using a M3 ring terminal to the bottom right PCB screw (near phone/line socket).

Telephone Line

The EDAC 222-02 does not require a separate line and can be inserted as a **master upstream** device in an existing telephone connection (see *Secure Installation* on next page). An RJ11 plug and socket system is used. You **must** use the cord-set provided to connect the EDAC 222-02 to the Telecom wall socket or the EDAC 222-02 may not work and no alarm notification calls will be made. Extra cords are available upon request for a small charge. The EDAC 222-02 may be used with a PABX (Private exchange) but it must be connected to an analog line.



WARNING: *If the existing phone system has lights on the phone it is probably a digital PABX system. Do **not** plug the EDAC 222-02 into a digital phone system unless you are sure that it supports standard analog phone equipment. Plugging the unit into an incorrect phone system will cause severe damage to the equipment and void the warranty. If there are any uncertainties please contact the supplier from whom you purchased your PABX for more information.*

Points To Note:

- The EDAC 222-02 can be connected between the telephone line (trunk) and the PABX or it can be used on an extension.
- When connected to a PABX **and** an extension, ensure that the extension socket the EDAC 222-02 is plugged into remains active during a power failure. Refer to your PABX instructions or contact your supplier.
- When programming phone numbers for your call list, remember to add the outside line number to the beginning of each programmed telephone number (this is usually **1** or **9**). Most PABX systems require a pause between the number you dial to get an outside line and the actual telephone number. Refer to *F11 Programming Your Telephone/Pager Numbers*, for details of how to do this.

The following schematic diagrams show typical EDAC 222-02 phone line installations:

Wall Socket Installation

Figure 2 shows a typical single wall socket installation and requires two telephone-related connections. Other telephones left off-hook may prevent the EDAC 222-02 from making calls. For this reason, we do not recommend this type of installation.

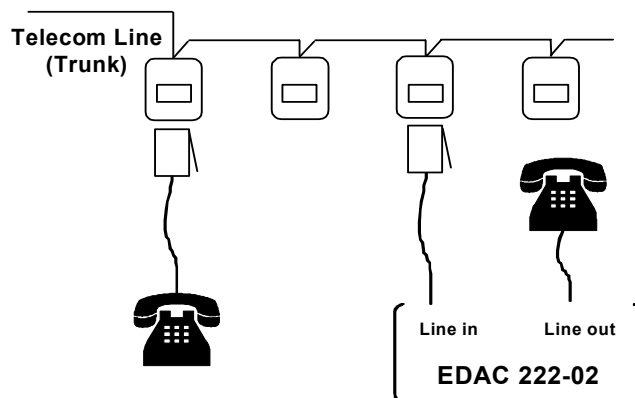

Figure 2: Wall Socket Installation

Secure Installation

This is a **master upstream device** configuration and may require Telecom assistance to remove the connection between the first wall socket and other wall sockets, as shown below. On an alarm Input trigger, the EDAC 222-02 takes over the telephone line, disconnecting all other calls. The alarm condition is immediately acted on and cannot be stopped by unauthorised means. When not triggered, the EDAC 222-02 has no effect on the phone line.

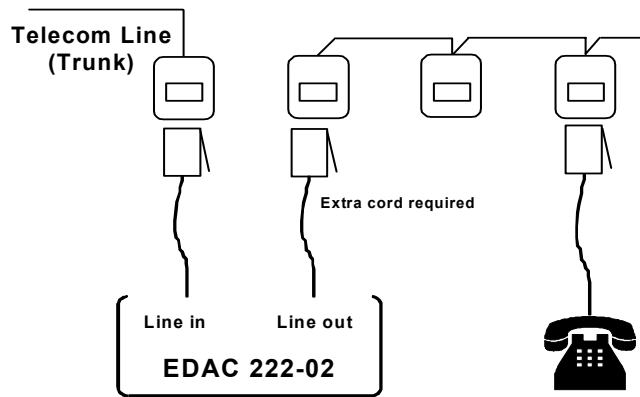



Figure 3: Secure Installation

Jumper Settings

Below is a table detailing the hardware jumpers on the EDAC 222-02. This is followed by a circuit board overlay, which details where the jumpers are located on the EDAC 222-02.

NOTE: If the memory or voice protection jumpers (702 and 602) are in the **lock** position, any new parameters you enter, such as phone numbers, will not be stored. This error can be easily detected by watching the numbers being played back for verification. The character display will show either an , for empty, or the previous numbers will be displayed rather than the newly entered ones.

Jumper	Function	Position/Mode	
J600	Speaker Mode	Up = Active (Default)	Down = Muted
J601	External Audio Input	Must be fitted to record voice using onboard microphone	
J602	Voice Message	Down = Open (Default)	Up = Secure
J702	Phone number & Parameters	Down = Open (Default)	Up = Secure

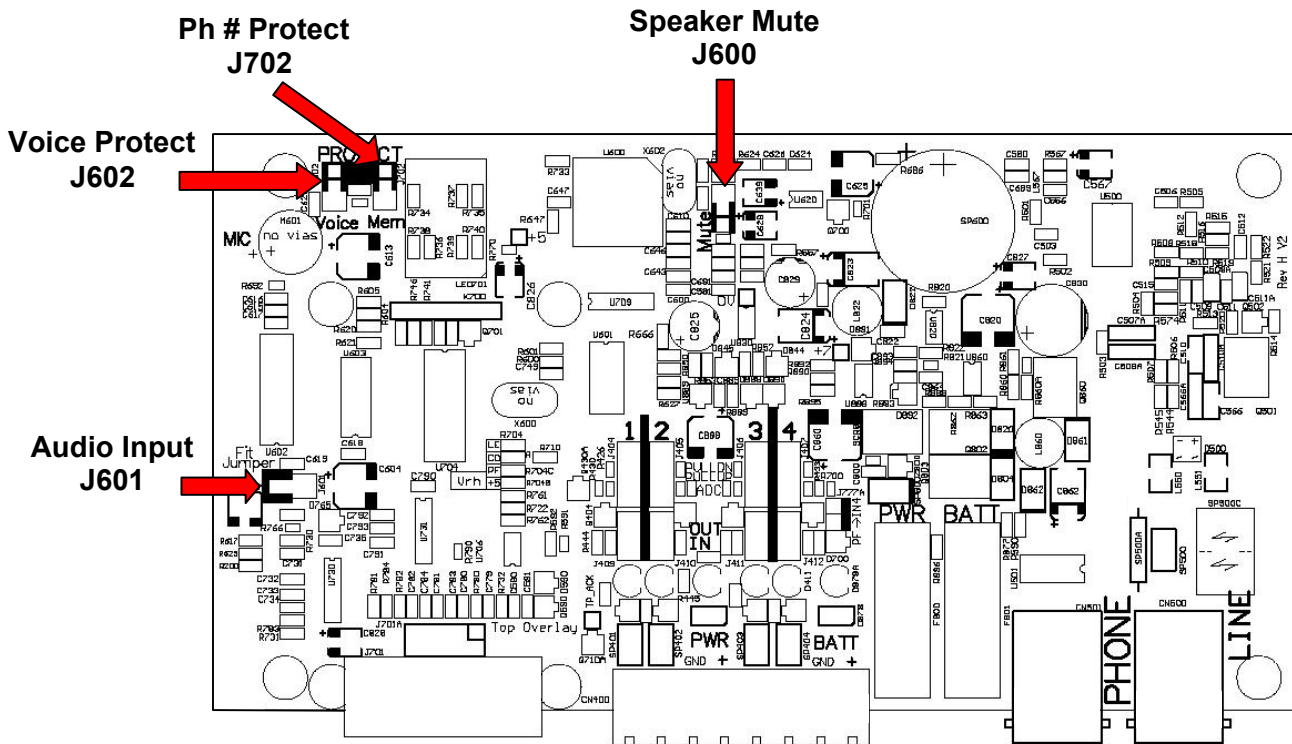

HOW THE EDAC 222-02 WORKS – RUN MODE

On power-up, the EDAC 222-02 will be in RUN mode assuming no trigger is present. RUN mode can be identified by a horizontal line on the display with a flashing dot .

Displays

RUN – MODE



= RUN mode (default at power up)



= Looking for dial tone



= Retry (function **F53 Wait Time** applies)



= Input is active, EDAC 222-02 cancelled

The EDAC 222-02 uses three distinct states when in RUN mode:

Active When the EDAC 222-02 is active (in alarm state) the unit will make alarm notification calls.

Cancelled or acknowledged When the EDAC 222-02 is active (in alarm state) the unit will make alarm notification calls. When these active trigger states (Inputs) have all been acknowledged the EDAC 222-02 is said to be in a cancelled state. This means that the EDAC 222-02 will not make any further calls. The Input is still present however and it must be removed in order to re-trigger the EDAC 222-02. Any new trigger on a different alarm Input will initiate a new alarm notification call sequence.

Cleared or idle The Input is cleared when it no longer meets the Input criterion (e.g. trigger on close contact and the contact is open). The EDAC 222-02 is idle when all Inputs are clear. (i.e. no Inputs present).

When an event triggers an alarm notification call, the EDAC 222-02 will dial through the telephone number call list. When the call is answered, the voice message is spoken or the pager message sent. This process is broken down into the following stages:

NOTE: *The references in brackets refer to the functions, which are programmed by you at the time of installation.*

1. All Inputs are idle (no alarms are being triggered).
2. An Input meets the alarm-trigger criteria (see functions **F51** and **F52**).
3. The EDAC 222-02 waits for the trigger/dial time to elapse (the time between the alarm trigger and the first phone call being made). If the Input is removed before the EDAC 222-02 has had time to place a call the Input state goes back to idle (see functions **F09** and **F96**).
4. The EDAC 222-02 will now make calls to the people on your call list (see functions **F07** and **F11**).
5. When a call is answered and it is a **voice** call (telephone, cell/mobile phone, etc) it will speak the message sequence outlined below.

Your site message (identifies the site)
The Input messages (identifies which alarms have been triggered)
The cancellation message (if you cancel the alarms) "The following Inputs have been acknowledged"
The Input messages again (if the alarms are cancelled but the Input triggers have not been removed)

This message sequence will be spoken repeatedly for whatever length of time you have set for Function **F55 Message Play Time**.

If the EDAC 222-02 is calling a **pager**, the pager equivalent of the voice message will be sent. You will need to go to a phone and dial into the EDAC 222-02, which will then speak the voice message sequence as outlined above.

6. Once the call duration time has been reached, the EDAC 222-02 will hang up the call. If **busy** tone was not detected the call is counted.
7. The EDAC 222-02 now waits for whatever time period you have set before making the next call in the call list (function **F53**). An  will be displayed indicating the dialler is in a retry state.
8. On receiving an alarm notification call, you should **acknowledge** (cancel) the alarm by pressing any key or entering the PIN number. This will stop the EDAC 222-02 from making more calls.
9. If the EDAC 222-02 hangs up before you have time to cancel, you can dial into the unit to cancel it (functions **F03**, **F04**, **F05** and **F06** to set cancellation options).

Telephone and **pager** programming functions are explained in separate sections of this manual. If you are using a pager, refer to the section *Using a Pager with the EDAC 222-02*, which explains how to use a pager with the EDAC 222-02.

Canceling Alarm Notification Calls

When the EDAC 222-02 is cancelled/acknowledged it will stop trying to make alarm notification calls. An alarm notification call may be cancelled by:

1. Receiving an alarm notification call.
2. Making a call to the EDAC 222-02 after receiving an alarm call.
3. Physical removal of the alarm condition.
4. Self-Cancel by counting calls.

1. Receiving an alarm notification call.

If you receive a call from the EDAC 222-02 and wish to acknowledge (cancel) the call, stopping further calls being made, press the PIN or any numeric key (0-9) on your telephone keypad while the alarm message is playing. The option of cancelling further calls by pressing any numeric key or using a PIN depends on the **call type**, which must be set by you in function **F11**.

The EDAC 222-02 will respond with beeps to confirm it has received your key presses and then announce which Inputs have been acknowledged. At this point, the person contacted may hang up their telephone. No other calls will be made by the EDAC 222-02 until a new trigger signal occurs.

If you do not wish to acknowledge the alarm, press the **#** key to make the EDAC 222-02 hang up and call the next number in its call list.

If you have acknowledged the alarm, pressing **#** will put the EDAC 222-02 into modem mode (you will hear fax tones). Hang up your phone – the EDAC 222-02 will automatically time-out and stop making further calls.

Pressing ***0#** will acknowledge the call and make the EDAC 222-02 hang up immediately. No further alarm notification calls will be made.

2. Making a call to the EDAC 222-02 after receiving an alarm call

This method is normally used to allow the EDAC 222-02 to be cancelled after receiving a call on your pager. It can also be used if the EDAC 222-02 hangs up before you have time to cancel. Go to a telephone and ring the telephone number of the EDAC 222-02. The EDAC 222-02 will answer and play messages to announce its current status. You may cancel (if allowed) by pressing a key or the PIN on your telephone (see functions **F03** and **F04**).

3. Physical removal of the alarm condition

Normally, removing the trigger signal immediately cancels the alarm condition and releases the telephone line regardless of what it is doing. The EDAC 222-02 will return to RUN mode.

NOTE: *This is only true if the physical Input is not latched by the EDAC 222-02 (see function **F52**).*

4. Self-Cancel by counting calls

When the number of calls set in function **F56 Call Counter**, is reached, the alarm condition is cancelled and the EDAC 222-02 will not make any further calls.

EXPLANATION OF PROMPTS – PROGRAMMING MODE



The **F** prompt indicates the EDAC 222-02 is in programming mode and is waiting for you to select a function.



The **P** prompt indicates the EDAC 222-02 is awaiting data entry.



The **E** prompt indicates the EDAC 222-02 has detected an error in the data entry process, or a number is empty. The **E** is also displayed for the number **12** in some functions.



The **t** prompt indicates the EDAC 222-02 is waiting for you to enter a call type. The seven-segment display cannot create a **t** character but the picture above is an accurate diagram of this prompt.



The **r** prompt indicates that a voice message is recording.

GETTING STARTED QUICKLY - EXAMPLE

Below is a brief description of how to quickly set up the essential functions of the EDAC 222-02. This simple configuration example will take you through the steps needed to:

- Program one telephone number for your alarm notification call list.
- Record one voice message to identify the site (location of the alarm).
- Record one voice message to report the alarm condition.
- Replay the recorded voice message so you can check it.
- Apply a physical trigger to any Input to initiate an alarm notification call and test that the unit is working.

Entering Programming Mode

Press  (the factory default PIN number).



The  prompt will appear on the display.

If your PIN is not working, turn the EDAC 222-02 off and hold down a key while powering up. The product will go into programming mode and display the  prompt.

Programming Telephone Numbers

Up to four telephone numbers can be entered for each alarm Input. For full instructions on how to program telephone numbers, refer to function **F11 Programming Your Telephone/Pager Numbers**.

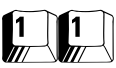
To enter phone or PABX extension number **one**:

 ⇒  ⇒  ⇒ Enter number followed by a  to save e.g.



(1 to get an outside line,  pause, 02432)

Then...







⇒  ⇒ Enter the call type  This means voice call, cancel using any key).

The EDAC 222-02 will then redisplay the entered telephone number followed by the call type so that you may verify their accuracy.

The dialler will return to the  prompt.

NOTE: By default, the call list is treated as one long list of 16 numbers which is applied to all Inputs.

Recording a Site Message







 ⇒   ⇒  ⇒  ⇒  = Recording starts as soon as the  key is pressed.

Press any key to finish the recording.

⇒  ⇒ The message will then play until any key is pressed.

Press any key again and the dialler will return to the  prompt.

Recording Input Trigger one Voice Message

 ⇒   ⇒  ⇒  ⇒  = Recording starts as soon as the  key is pressed.







Press any key to finish the recording.

⇒  ⇒ The message will then play until a key is pressed.

Press any key again and the EDAC 222-02 will return to the  prompt.

See function **F0*** for the full list of voice message functions.



Replaying the Recorded Message





 ⇒   ⇒  ⇒  ⇒  = Playback starts as soon as the  key is pressed.

⇒  ⇒ The message will then play until any key is pressed.

The EDAC 222-02 will return to the  prompt when complete.

Exit to Run Mode

 ⇒   = Exit programming to RUN mode.

Once all these functions have been programmed, exit programming mode by pressing  very quickly at the  prompt. The EDAC 222-02 should now display the  with a flashing dot. Pressing too slowly causes the display to cycle through the product software version number before returning to the  prompt. This indicates that the unit is still in programming mode. In RUN mode the EDAC 222-02 is ready to accept an Input trigger and make alarm notification calls.

Testing the EDAC 222-02

By default the Input is set up for **normally open**. Connecting the Input terminal to negative supply will trigger the EDAC 222-02.

Use a paper clip or small piece of wire to connect any Input to **ground** (third terminal from the left). This will make a closed connection, causing the Input to trigger and the EDAC 222-02 to make an alarm notification call.

HOW TO PROGRAM THE EDAC 222-02

Introduction

The EDAC 222-02 can be used to report two different types of Input alarm as configured by the user. When an Input alarm is triggered, it will cause the EDAC 222-02 to auto-dial the list of phone numbers it has been programmed with. By default, a single list of 16 phone numbers is available for use with any alarm type. These 16 phone numbers can be divided into 4 lists of four numbers each. Each of the Input alarms can use a separate list of four phone numbers to call when the alarm is triggered. This separate list can also then be alternated with the two remaining lists using the rosters function.

Definition of Terms Used

Parameter: A value that must be entered by the user such as a phone number.







Input: The Input is the physical event that triggers the EDAC 222-02 to make alarm notification calls.

Call type: The type of call being made by the EDAC 222-02 to the user. This will be a voice call, pager or text message. The call type also defines your alarm cancellation options. See section *Call Types* on page 29 for a list of call type options.



Tips For Use:

NOTE: *Jumper J702 (Phone Numbers & Parameters) must be set open (down) or your settings will not be stored. See Jumper Settings in the Installation section.*

- Functions not being used should be left at factory default settings. If the product appears to be acting erratically or is being relocated to a new site, we recommend resetting it to factory defaults.

NOTE: *The factory defaults can be re-installed at any time by entering the pin number (factory default 0000) and at the  prompt pressing , , ,  then .*

The Key - Program Checking

The  key is used to display current parameter data held in the EDAC 222-02. Select a function and, when the  is displayed, press the  key. The data currently held in that function will display (digit by digit in the case of multi-digit entries).

NOTE: *The  key is also used to insert a 2-second **pause** when entering phone numbers. See function **F11** for an explanation of how this may be used with a PABX system.*

Fixing Data Entry Errors

Should incorrect data be entered, at the **F** prompt simply re-select the function number and re-enter the parameter data.

If the **F** prompt is not displayed, press **⌘** repeatedly until it returns

Programming the Functions for Individual Alarm Inputs

The functions in this manual are all referred to by numbers e.g. function **F53 Wait Time Between Calls**. The numbers after the **F** are what you enter into the EDAC 222-02 to let the unit know which function you are setting. These numbers will differ depending on which of the two Inputs (alarms) you are setting.

When you program functions for Input **1**, the function number will always begin with either a **1** or a **5**. For example: **F11, F51, F52, F53**.

To program functions for Input **2** you will need to change the number following the **F**.

For example, function **F53** Wait time, determines the period to wait between one call and the next.

- To program the wait time for Input **1**, you will enter **53** at the **F** prompt.
- To program the wait time for Input **2**, you will enter **63** at the **F** prompt.

The tables below summarise how to convert the function numbers for each Input.

When programming functions for:	Input 1	Input 2
If the function begins with a 1	Follow the instructions in the manual	Change the first number to 2, e.g. F11 becomes F21

When programming functions for:	Input 1	Input 2
If the function begins with a 5	Follow the instructions in the manual	Change the first number to 6, e.g. F53 becomes F63

Entering Programming Mode

To enter programming mode enter the PIN number.





The factory default PIN is 



The character display will now show the  prompt.

What to do if you Forget your PIN Number

If your PIN is not working, remove the power from the EDAC 222-02. Reapply the power while holding down any key. The product will go into programming mode and display the  prompt. To choose a new PIN number use function **F00 Modify PIN Number**.

Exit to RUN Mode

Once all the functions have been programmed, exit programming mode by pressing  very quickly at the  prompt. Pressing too slowly causes the display to cycle through the product software version number before returning to the  prompt (still in programming mode). The EDAC 222-02 should now display the  with a flashing dot. In RUN mode the EDAC 222-02 is ready to accept an Input trigger and make alarm notification calls.

 ⇒  = Exit programming to RUN mode.



Restore Factory Defaults

Use this function to clear old or unknown parameters (user settings) and return to factory settings. You can then reprogram each function from the default starting point

NOTE: *This procedure does not affect any existing voice messages.*

NOTE: *Jumper J702 (Phone Numbers & Parameters) must be set open (down) or your settings will not be stored. See Jumper Settings in the Installation section.*



WARNING: *The following instructions will clear your user settings from all functions associated with an Input, e.g.    will clear the phone/pager numbers, trigger type, wait time, message play time and call counter for Input one. If you wish to reset only one or two functions, look up those functions in this manual and simply reprogram the data .*



= Clear general parameters (functions **F01** to **F09**).



= Clear phone numbers and all parameters for Input 1.



= Clear phone numbers and all parameters for Input 2.



Function F0* Recording Voice Messages



The operator can re-record all voice messages in the EDAC 222-02. Voice messages are recorded on to an analogue EEPROM for permanent storage using the microphone provided on the EDAC 222-02. The message is played back through the onboard speaker. The Speaker Mute jumper (J600) **must** be in the top most position (un-muted) to hear any message playback. see *Jumper Settings* in the *Installation* section.

Jumper J602 is provided to protect your recorded messages in EEPROM from being accidentally erased. At the time of shipping the default position is to the down/bottom (unprotected) position, allowing messages to be re-recorded, for your installation configuration.





NOTE: You **must** ensure that the voice protection jumper (J602) is in the **down/bottom** position before attempting to record a message or your message will not be recorded.

Play and Record control keys

All voice messages start with  this is the function number. After this a  for parameter will be displayed and a parameter must be entered. Use the tables below to select a parameter for the different voice message slots.

To **start recording** press  after entering the parameter number. Recording starts immediately, and is indicated by a  being displayed.

Press any key to finish recording. The message will be played back automatically. Then the  prompt will return.

To play back a previously recorded message enter  followed by the parameter at the  prompt. Then press  to hear the message. Press any key to return to the  prompt.

F0*0	Site message (spoken to identify the EDAC 222-02 installation)
F0*9	Idle message ("All Inputs are clear")
F0**	Cancel message ("The following Inputs have been acknowledged")
F0*#	Output mode

Inputs	F0*1	Input 1 active message (Eight seconds max)
	F0*2	Input 2 active message (Eight seconds max)

Outputs	F0*3	Output 2 On message (four seconds max)
	F0*4	Output 1 On message (four seconds max)
	F0*7	Output 2 Off message (four seconds max)
	F0*8	Output 1 Off message (four seconds max)

RECORD example

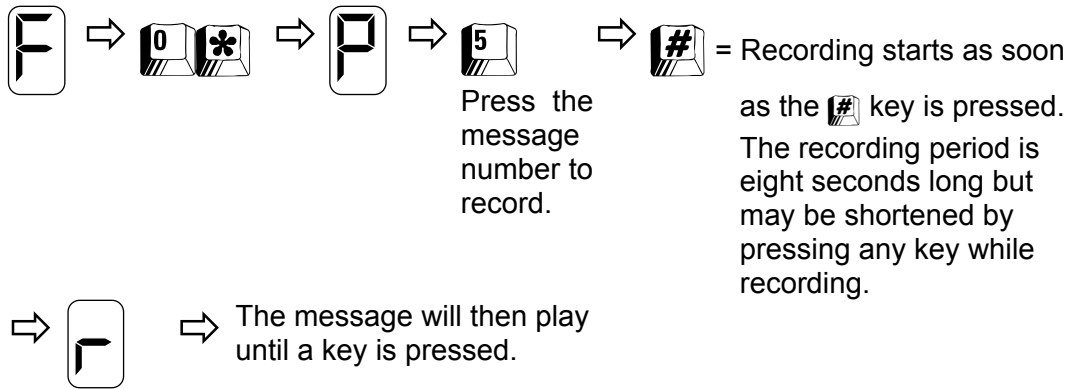

PLAY example

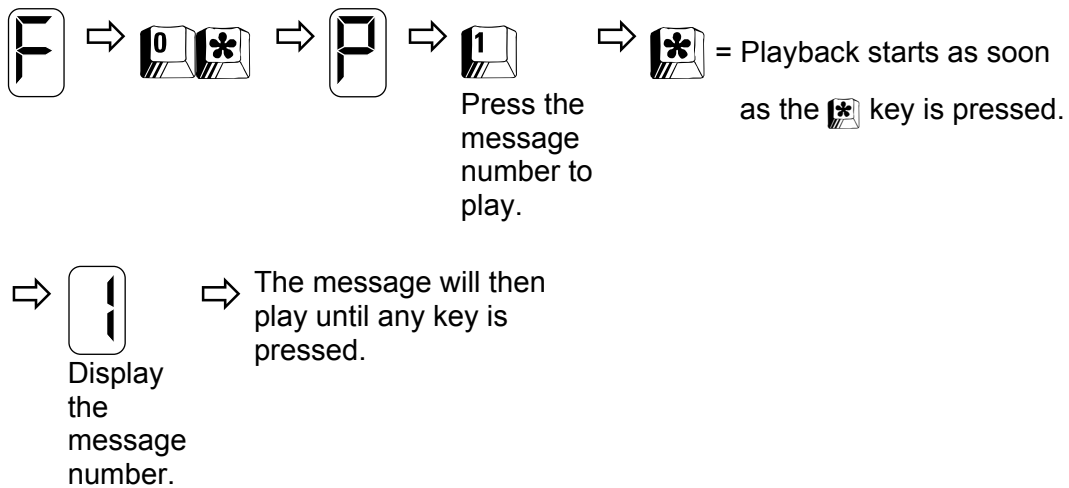

Function F00 Modify PIN Number

The factory default PIN is . If you forget the PIN you can still enter programming mode by holding down any key when applying power to the EDAC 222-02.

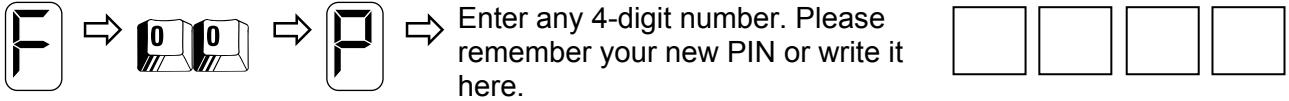

Default: 

Function F02 Call Progress

By default, before the EDAC 222-02 places a call it will try to detect **dial** tone to see if a call can be made. Once detected, the EDAC 222-02 will dial the number and immediately start speaking its message. We recommend you use **dial tone detection only**. If you wish to use dial and ring detect (setting this function to **3**) you should be aware that it may take six seconds for the EDAC 222-02 to detect that ringing has ceased. It is likely that an impatient person may hang-up before hearing the message.

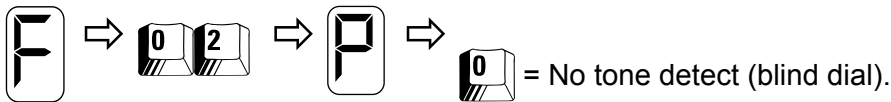

Picks up the line, waits five seconds then dials the number. The voice messages are then spoken for the play time (set in function **F55**).

 = Dial tone detect only.

Picks up the line and makes two attempts to detect dial tone. If detected, dials the number and the voice messages are spoken for the play time (set in function **F55**). If not detected tries the next number.

 = Ring tone detect only.

Picks up line as 0 (no tone detect) above. If tones other than RING tone are detected the call is aborted and the next number is tried. Once ringing, the EDAC 222-02 must detect silence before speaking message.

 = Dial and Ring.

Detects both dial tone and ring as in 1 and 2 above.

Default: 1 (Dial tone only)

Note: Please see Telecom certification requirements over the page

Australian Certification Requirements

If the dial tone detect is disabled (function **F02 Call Progress** is set to **0** or **2**) then the device must not make more than three call attempts to the same number. See function **F56 Call Counter**, which must be set to **1**, **2** or **3**, which limits the number of calls made. This also applies to function **F66** (for input 2) if used.

Also see section *Compliance Notes*.

If the value in function **F02 Call Progress**, is set to **1** or **3** (dial tone detection enabled) then the value in function **F56** must be set to between **1** and **9**.

This also applies to function **F66** (for input 2) if used.

New Zealand Telepermit Requirements

If the dial tone detect is disabled (function **F02 Call Progress** is set to **0** or **2**) then the device must not make more than 10 call attempts within a 30 minute period to the same number. See function **F56 Call Counter**, to set call limit between 1 and 9, and function **F53 Wait Time Between Calls**, to set the time between calls. This also applies to functions **F66** (for input 2) and functions **F63** (for input 2) if used.

Also see section *Compliance Notes*.

Function F03 Cancel Options When Making a Call to the EDAC 222-02

This method is normally used to allow the EDAC 222-02 to be cancelled after receiving a call on your pager. It can also be used if the EDAC 222-02 hangs up before you have time to cancel.

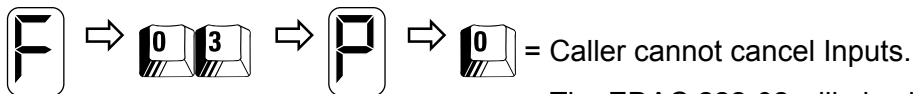

The EDAC 222-02 will play its voice messages and not stop making calls.

 = Input cancelled by any number key.

Pressing  and  does **not** cancel the Input.

 = Input cancelled by PIN.

Default: 1 (Cancel by any number key)

You will need to allow the EDAC 222-02 to answer incoming calls so that you may cancel the alarm notification calls. Use function **F53 Wait Time Between Calls**, to provide a window for the operator to make a call to the EDAC 222-02 and **F04** or **F05** to set the options for incoming calls.

Function F04 Answer Incoming Calls When any Input Active

When an Input is active the EDAC 222-02 will attempt to make alarm notification calls. Setting a wait time (function **F53**) gives you the opportunity to call into the EDAC 222-02 and cancel the Input. When an Input is cancelled, the alarm condition still exists but the EDAC 222-02 will stop making alarm notification calls.

The EDAC 222-02 will only use this function and its setting when any Input is active.

NOTE: Do not use one ring.

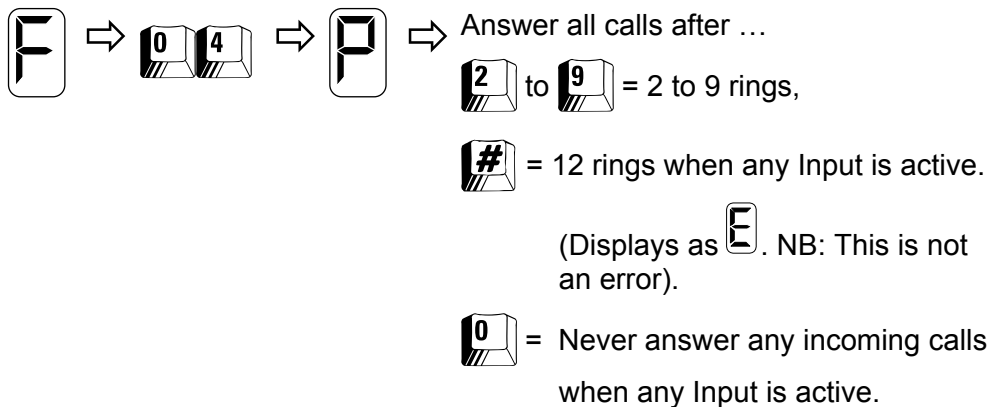

Default: 4 (Answer after four rings when any Input active)

Function F05 Answer Incoming Calls When all Inputs are Cancelled

When an Input is cancelled, the alarm condition still exists but the EDAC 222-02 will stop making alarm notification calls. If you wish to monitor the status of an alarm you can call into the EDAC 222-02 periodically and listen to its message. Monitoring Input (alarm) status can be useful as certain alarm conditions may go away by themselves e.g. electrical power will be automatically restored after a power failure. In this instance the alarm condition is removed automatically and the EDAC 222-02 will reset itself to the idle state.

The EDAC 222-02 will only use this value when all active Inputs are cancelled but not removed.

NOTE: Do not use one ring.

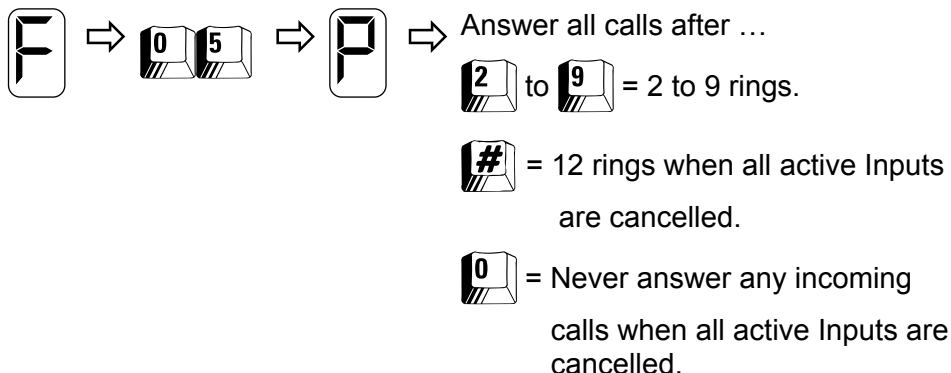

Default: 4 (Answer call after four rings)

Function F06 Answer Incoming Calls When no Inputs Active (Idle)

You may wish to periodically dial into the EDAC 222-02 to confirm that it is in idle state. This can be useful if you have previously received a notification call of an alarm which may cancel itself e.g. electrical power will be automatically restored after a power failure. Because the alarm condition is removed, the EDAC 222-02 will reset itself to the idle state.

The EDAC 222-02 will use this value only when there are no Inputs active and the EDAC 222-02 is in the idle state.

NOTE: Do not use one ring.

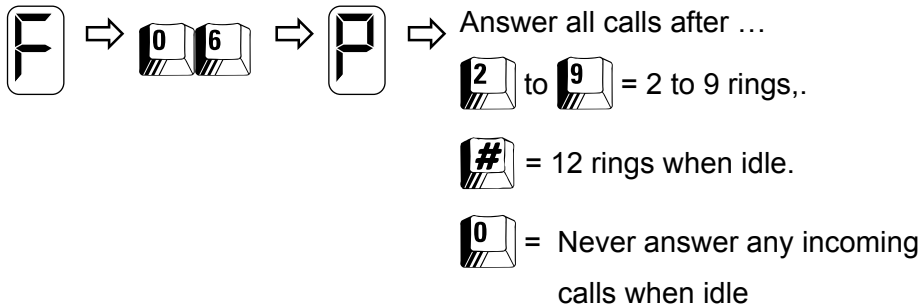

Default: 4 (Answer calls after four rings)

NOTE: *If using Outputs, or remote modem configuration, you will need to consider appropriate values for functions **F04**, **F05** and **F06**, to ensure the EDAC 222-02 answers the phone appropriately.*





For installations that only use voice alarm notification calls where no user call back is required, functions **F04**, **F05** and **F06** can be set to zero ensuring the EDAC 222-02 will never answer an incoming alarm call. This allows the phone line to be used for other day-to-day activities. This configuration requires that the operator acknowledges the alarm notification call on the phone they receive the alarm notification call on.

Function F07 Call List Priority & Rosters

The EDAC 222-02 can be programmed with up to 16 different phone numbers. By default the programmed numbers are treated as a single list of 16 numbers. Using **F07** the list can be divided up in to blocks of 4, or 8 and treated differently depending on the alarm Input trigger number.

The list of telephone/pager numbers can be configured in a number of ways including rosters.

A roster is used to assign a specific call list to call only the people who will be on duty that day. You can program four separate lists of four phone numbers, and change which list is to be used either remotely or on site.

When the call is established and the EDAC 222-02 is speaking the idle message, the current roster may be changed by pressing  followed by the roster number (, ,  or .

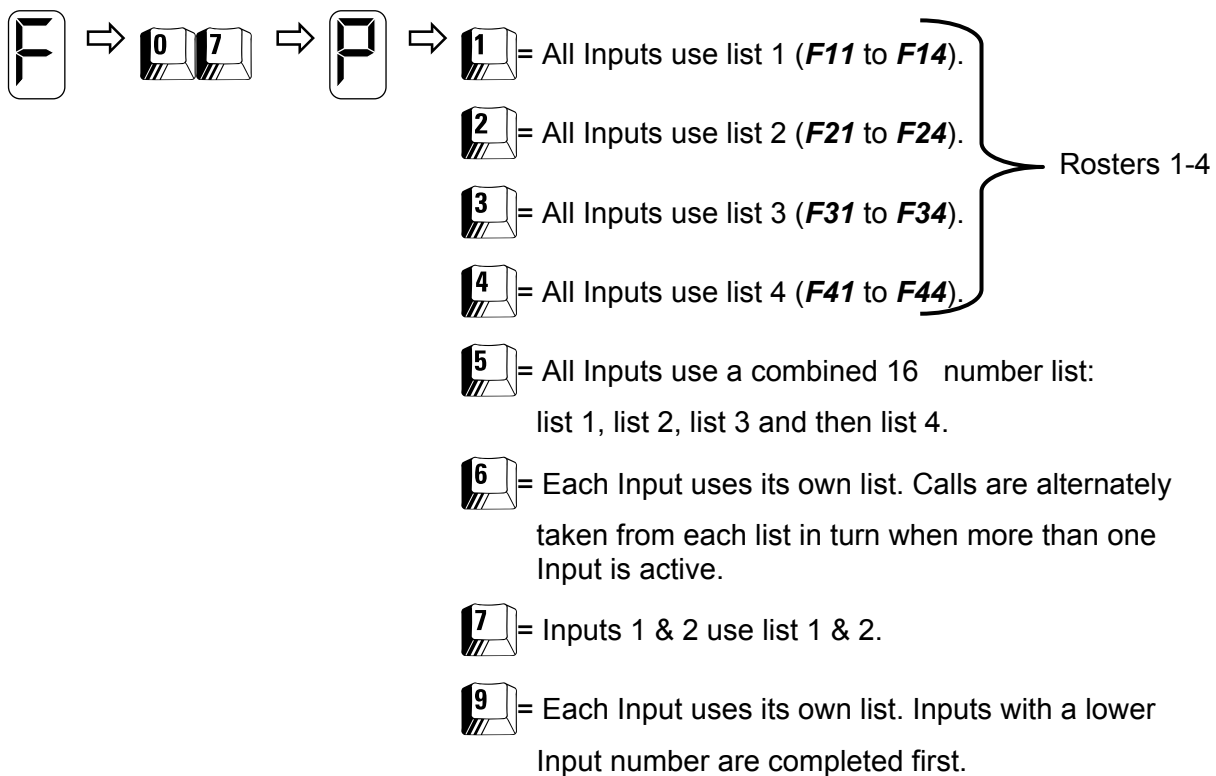

Default: 5 (One list of 16 numbers)

Function F09 Trigger/Dial Time

This function determines the period to wait from physical trigger to alarm condition and dial out. It can be used as a trigger delay timer to allow for exit entry time, or can be used with float switches to ensure the level has got to and is triggering the float switch correctly.

The **latch** capture, (function **F52**) occurs either when triggered, or at the end of the trig/dial time. The value displayed is seconds by default. Minutes may be used (see function **F96**)

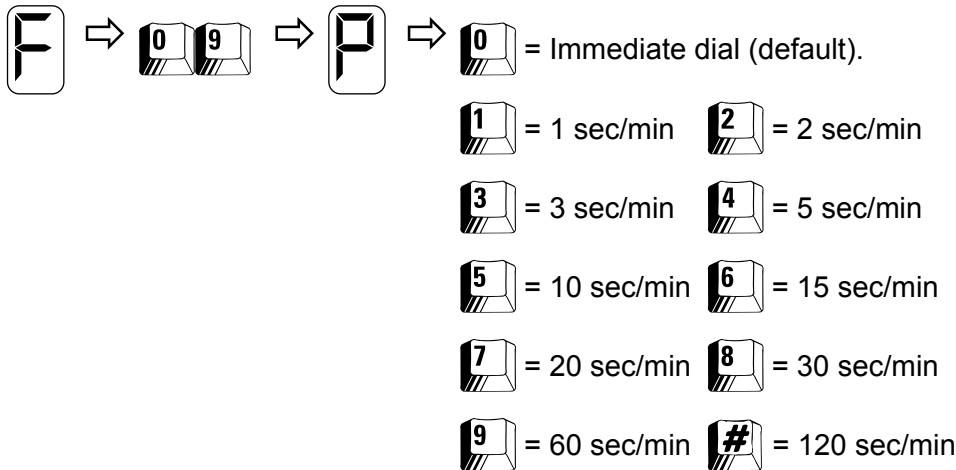



Default: 0 (Start dialling when triggered)

Function F10 Programming Your Pager Messages

When an alarm notification call is made to a **Numeric-Pager**, the message in this function is sent.

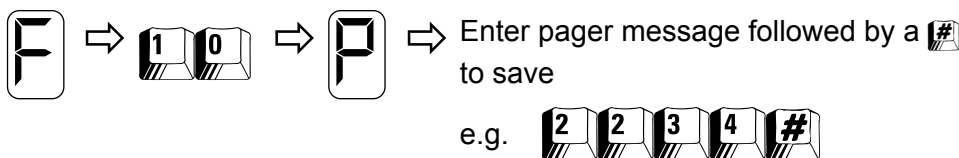
Message **one** is entered as follows:



Default: Empty (Displays as  for Empty)

Each of the four Input pager messages must be programmed separately as follows:

- Use **F10** for Input 1 pager message 1 as in the example above.
- Use **F20** for Input 2 pager message 2.

To reset a pager message to empty: Select the message, do not enter a message and save using the  key.

Function F11 Programming Your Telephone/Pager Numbers

The EDAC 222-02 can be programmed with up to 16 different phone numbers. Each Input can have one list of up to 4 phone numbers, associated with it, a total of 16 numbers can be programmed into the EDAC 222-02.





By default the programmed numbers are treated as a single list of 16 numbers. Using function **F07 Call List Priority**, the list can be divided up and treated differently depending on the alarm Input trigger number. See function **F07**

When the alarm Input is activated, the EDAC 222-02 will start to dial through the call list, always starting with the first phone number on the call list, then the next and so on. When programming phone numbers and/or pager numbers they may be entered in any order. However, alarm notification calls will be made in the function sequence number in the table below while applying the rule selected in function **F07 Call List Priority**.

Slot #	Function		Slot #	Function	
1	F11	Input \ Roster 1	9	F31	Roster 3
2	F12		10	F32	
3	F13		11	F33	
4	F14		12	F34	
5	F21	Input \ Roster 2	13	F41	Roster 4
6	F22		14	F42	
7	F23		15	F43	
8	F24		16	F44	

When using pagers, the RIC code of the pager, which is normally written on the pager, should be entered into one of these phone number slots. See *Using a Pager with the EDAC 222-02*.

If you are using a PABX: Sometimes problems can be encountered when getting the EDAC 222-02 to dial an outside line. Usually this occurs when the **outside line number** (e.g. 1 or 9) is dialled and the EDAC 222-02 begins dialling the phone number **before** the PABX can produce the outside line dial tone. This results in the first few numbers being missed by the PABX. This problem can be overcome by putting more pauses between the outside line number and the phone number to be dialled. If you are using a PABX system, a two-second pause may be inserted using the  key. You cannot start or end with a pause.

 ⇒   ⇒  ⇒ Enter number followed by a  to save
e.g.

(1 to get an outside line,  pause, 02432)

Then...





⇒  ⇒ Enter the **call type** (see *Call Types* on page 29)
e.g.



The number is then displayed for checking.

Each subsequent phone number to be dialed is entered in the same manner: **12** is Input one, phone number two, **21** is Input 2, phone number one or phone number five, if **F07** is on default setting of 5, providing one call list of 16 numbers (see table previous page).





The telephone numbers for Input two can be entered by repeating the sequence starting from the  prompt using **21-24**. For example **23** would refer to Input 2, phone number three, or phone number 7 if on default **F07** setting.

Clearing a Telephone Number: Enter the function (**F11-14** or **F21-24**) and enter the  key without a number. An  will be displayed to show it is empty. To clear the complete list for one Input use  (call list for Input 1),  (call list for Input 2).

NOTE: *If the memory jumper (J702) is in the **Protect** position, any new parameters you enter, such as phone numbers, will not be stored. This error can be easily detected by watching the numbers being played back for verification. The character display will show either an , for empty, or the previous numbers will be displayed rather than the newly entered ones. See Jumper Settings in the Installation section of the manual for information on jumper settings.*

Call Types

The 'call type' selects the type of call being made by the EDAC 222-02 to the user e.g. voice or pager. It also sets an option for how the alarm notification call associated with this number will be cancelled/acknowledged.

	Voice call	Cancel not allowed
	Voice call	Cancel by any number key
	Voice call	Cancel by PIN
	Numeric pager	Timed call using function F54
	Numeric pager	Call progress detection

Points To Note:

- You select a call type when you program each individual phone number. This provides the flexibility for some phone numbers being set to 'cancel by any key' and some being set to 'cancel by PIN' e.g. if the EDAC 222-02 is going to make an alarm notification call which could be received by the wrong person (such as a baby sitter), you might like to set this number to cancel by PIN to ensure any alarms do not get accidentally cancelled by the wrong person.
- Cancel methods shown here apply only to outgoing alarm notification calls made by the EDAC 222-02 to a human operator **not** incoming calls. See **F03 Cancel Option When Making an Incoming Call** for this.

Function F51 Setting Inputs to Trigger or Report

An Input may be configured as triggering or reporting. A triggering Input triggers alarm notification calls. A reporting Input will not cause the EDAC 222-02 to make any calls. A reporting Input will speak its message either when the EDAC 222-02 has already been triggered by another Input and is making an alarm notification call, or when you call into the unit to check its status (active, cancelled or idle).

Set Input **one** as follows:

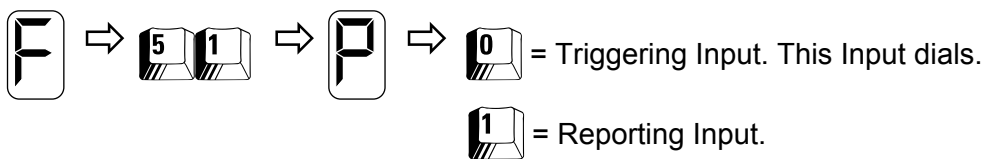

When another Input is dialling this Input reports. This Input will not cause the EDAC 222-02 to make any calls.

Default: 0 (Triggering)

By default both Inputs are set to triggering. Both Inputs must be programmed separately to change them from triggering to reporting, as follows:

- Use **F51** for Input 1, as in the example above.
- Use **F61** for Input 2.

Function F52 Physical Input Trigger Configuration

You can configure the Input to trigger on **normally open** (N.O.) or **normally closed** (N.C.) contacts. The pull-ups may be changed to pull-downs by moving the appropriate Input channel jumper (see *Jumper Settings* in the *Installation* section). Any unused Inputs must be treated as normally open.

The EDAC 222-02 can **latch** an Input so that, even though the physical trigger is removed or gone back to its normal state, the EDAC 222-02 continues to make alarm notification calls. The Input latches **after** the latch time as defined in function **F09**. Function **F96** determines how the time in function **F09** is applied and in what units (Seconds or Minutes).

By default the Input triggers are set up to be **non-latching**. This means that when the Input trigger is removed, the EDAC 222-02 will stop making alarm notification calls.

By default the Input is set up for **normally open**. Connecting the Input terminal to negative supply will trigger the EDAC 222-02.

Alternatively the Input can be set up for **normally closed**, Input terminal connected to negative supply. Opening the connection will trigger the EDAC 222-02.

The trigger type for Input **one** is set as follows:

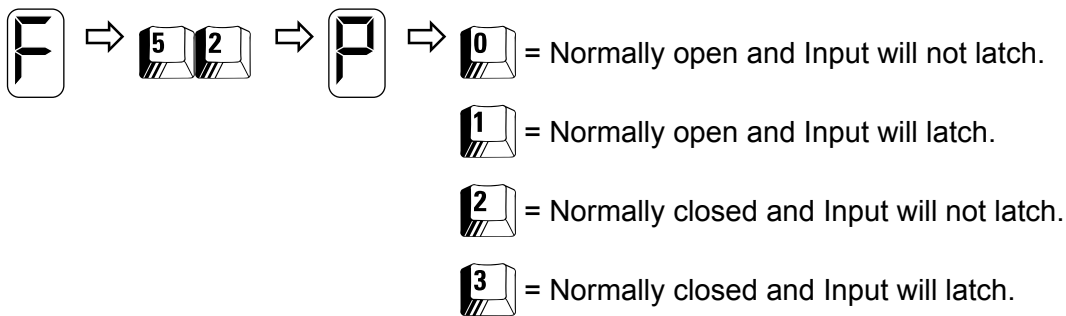

Default: 0 (Normally open)

By default both Inputs are set to normally open and Input will not latch. Both Inputs must be programmed separately to change them from normally open non-latching as follows:

- Use **F52** for Input **1**, as in the example above.
- Use **F62** for Input **2**.

Function F53 Wait Time Between Calls

This function determines the period to wait between one call and the next. The wait time allows an opportunity for an operator to call into the EDAC 222-02 to cancel the Input or listen to the current status message. Each individual Input has its own wait time.

Set the wait time for Input **one** as follows:

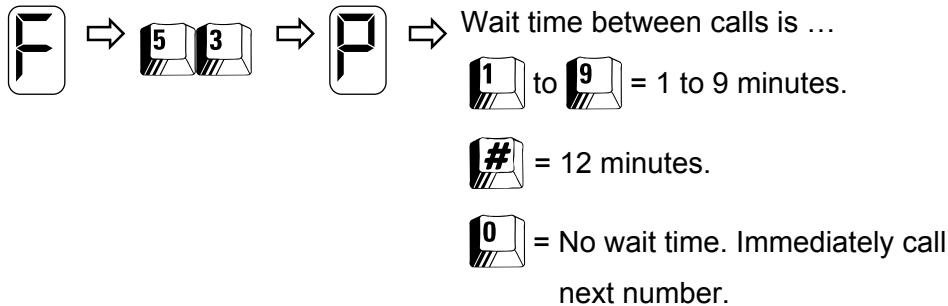

Default: 4 (Four minutes)

Both Inputs must be programmed separately as follows:

- Use **F53** for Input **1**, as in the example above.
- Use **F63** for Input **2**.

Function F54 Pager Delay Time

The pager delay time only relates to numeric pager calls (see function **F11**). This is the time from dialling the number to when the paging network answers the call. The EDAC 222-02 sends the DTMF pager message at this point. You can determine this time by dialling the pager network with a telephone and measuring the period from dialling the number until the call is answered.

The pager delay time for Input **one** is set as follows:

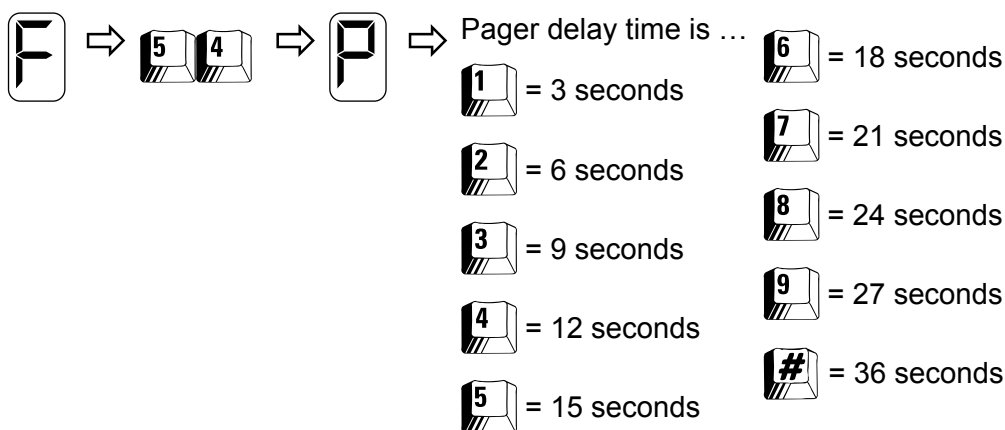

Default: 4 (Twelve seconds)

Both Inputs must be programmed separately as follows:

- Use **F54** for Input **1**, as in the example above.
- Use **F64** for Input **2**.

Function F55 Message Play Time

The Message Play Time is the amount of time, in minutes, that the EDAC 222-02 is allowed to be off hook to dial the number, speak messages and accept a cancellation by any key or PIN. The EDAC 222-02 will speak the message for the playtime before the call is terminated. The play time starts from when the EDAC 222-02 starts to dial. The messages are spoken repeatedly as follows:

When any Input/s active:

Site message
Active Input messages
Cancel message
Input messages cancelled but not cleared

When all Inputs are clear:

Site message
Idle message twice
Hang-up call

When all Inputs are cancelled:

Site message
Cancel message
Input messages cancelled but not cleared
Hang-up call

Normally the voice message will start speaking as soon as the EDAC 222-02 has finished dialling the number. This means that you may miss hearing the first part of the voice message. With ring detection, the voice message starts after the call is answered.

The playtime for Input **one** is set as follows:

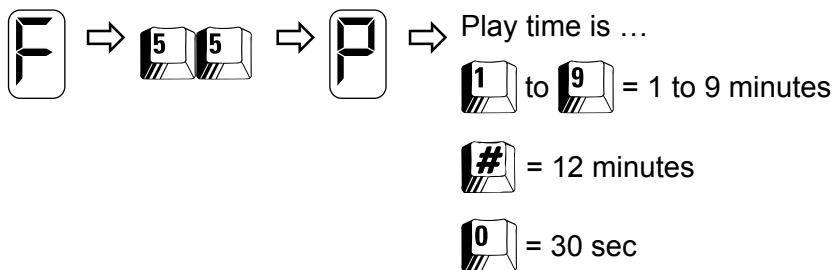

Default: 2 (Two minutes)

Both Inputs must be programmed separately as follows:

- Use **F55** for Input **1**, as in the example above.
- Use **F65** for Input **2**.

Function F56 Call Counter

As successful telephone/pager calls are made they are counted. The Input alarm condition is automatically self cancelled when the number of calls made exceeds the value set in this function. If a call was not successful (e.g. the telephone was BUSY) the call is not counted.

The call counter for Input **one** is set as follows:

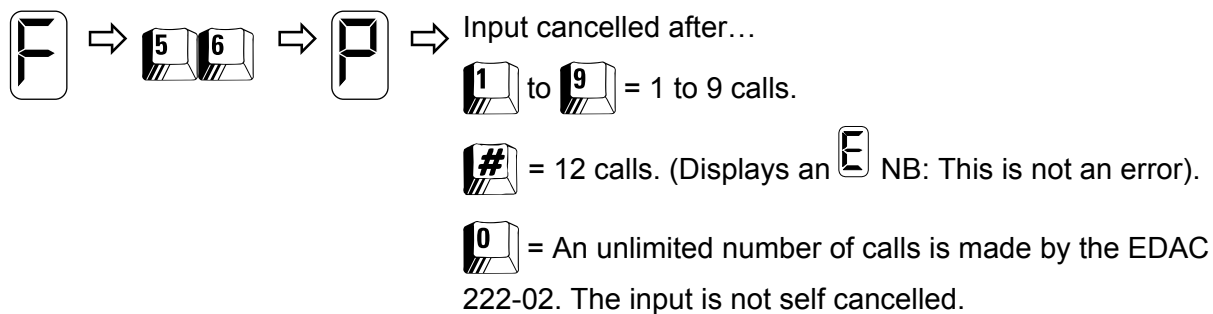

Default: 0 (Unlimited number of calls made)

Both Inputs must be programmed separately as follows:

- Use **F56** for Input **1**, as in the example above.
- Use **F66** for Input **2**.

MISCELLANEOUS FUNCTIONS

Function F96 Trigger/dial Mode

When an alarm Input is present the EDAC 222-02 will trigger. The EDAC 222-02 will not begin calling until the trigger/dial time has passed (see function **F09**). Function **F96** is used to set the units used (seconds or minutes) by the trigger/dial time in **F09**.

When the Input is **latching** the Input can be latched either at the trigger time or at the dial time (see function **F52**). **Latch on trigger** means once the EDAC 222-02 has been triggered it will continue until it is acknowledged. If the Input is set to **latch on dial** and the trigger is removed before the dial has commenced the EDAC 222-02 will cancel and stop making calls. With function **F52** set as non-latching, the latch on trigger and latch on dial have no effect. The trigger dial time is always relevant.

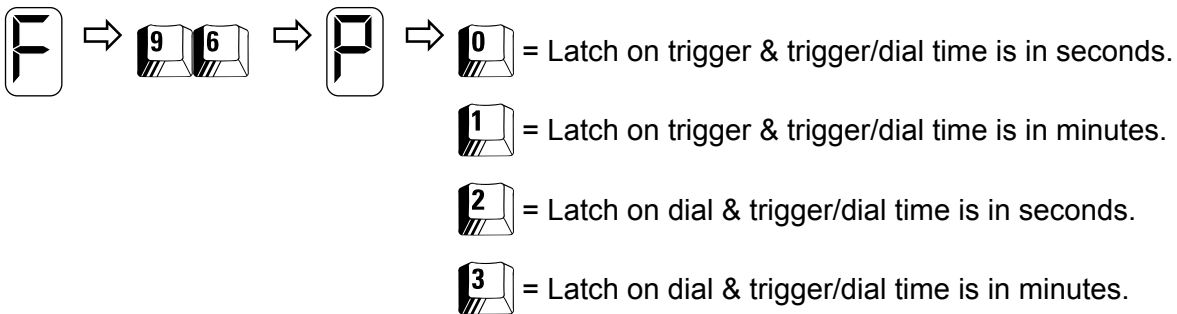

Default: 0 (Latch on trigger & trigger/dial time is in seconds)

USING A PAGER WITH THE EDAC 222-02

Numeric Pager

The most basic form of paging is to use a numeric pager. This type of pager can only display numbers or codes. When making an alarm notification call to a numeric pager you must enter the RIC code of the pager into a suitable phone number slot (see function **F11**), and select a call type. The call type will either be **Call Type 8** (timed call using function **F54**) or **Call Type 1#** (call progress detection).

NOTE: *If you are using a PABX, you will need to add the access code for an outside line and a pause.*

Timed Call Using F54 Pager Delay time

This is the time from dialling the number to when the paging network answers the call. The EDAC 222-02 sends the DTMF pager message at this point. You can determine this time by dialling the pager network with a telephone and measuring the period from dialling the number until the call is answered.

Call Progress Detection

When using this setting, the dialler will attempt to detect the status of the call and send the pager message in **F10** at the appropriate time. It is more common to use **Timed Call** using function **F54** (*Pager Delay Time*).

When using the EDAC 222-02 with a pager, you will need to set a wait time between calls (function **F53**) so that you can call into the EDAC 222-02 to cancel the alarm, stopping further calls from being made.

Use function **F04** to set the number of rings before answer for an incoming call when any input is active. Default is four rings before auto answer.

Use function **F03** to set cancellation options (Cancel by any key or PIN) for an incoming call to the EDAC 222-02. Default is 'Cancel by any key.'

ADVANCED FEATURES

Outputs

Each Output can be used to open or close a ground connection . To toggle an Output you must call the EDAC 222-02 when the EDAC 222-02 is in idle mode, i.e. all Inputs have been cancelled or there are no active Inputs. Functions **F05 Answer Incoming Calls When all Inputs are Cancelled** and function **F06 Answer Incoming Calls When no Inputs active** must be configured appropriately. Once the EDAC 222-02 has answered, the idle message is spoken twice. Enter Output mode by pressing the PIN while the Site message is being played.

The Output mode message will speak along with each Output message (either off or on). The Output on message is spoken when the Output is grounded.

Pressing  or  toggles the state of Outputs 1 and 2 respectively.

If no key press is detected for 15 seconds the EDAC 222-02 will terminate the call.

 will also terminate the call.

NOTE: *All Outputs return to 'off' when the power is removed.*

FREQUENTLY ASKED QUESTIONS

“I’ve plugged the EDAC 222-02 in but nothing happens.”

Check that the power supply you are using is 12-15V direct current (DC). Also check that the polarity of the supply is correct at the terminals of the EDAC 222-02. Check also for shorts and fractures in the cable supplying the power to the EDAC 222-02. A good indication is to connect a multimeter set to the DC volts range across the + and – terminals on the EDAC 222-02 to check that the correct input voltage is present.

“The EDAC 222-02 will trigger but doesn’t make a call. What’s going wrong?”

The most likely cause is that the EDAC 222-02 is not seeing dial tone. Listen to the speaker when the EDAC 222-02 is attempting to dial. If **you** cannot hear the dial tone then neither can the EDAC 222-02. Check that you are using the line cord supplied with the product to connect the product to the wall socket, and that it is correctly connected at both ends.

When using a **PABX** system, problems can be encountered when getting the EDAC 222-02 to dial an outside line. Usually this occurs when the **outside line number** (e.g. 1 or 9) is dialled and the EDAC 222-02 begins dialling the phone number **before** the PABX can produce the outside line dial tone. This results in the first few numbers being missed by the PABX. This problem can be overcome by putting more pauses between the outside line number and the phone number to be dialled (see function **F11** to **F14 Programming Your Telephone/Pager Numbers**).

“The EDAC 222-02 calls out O.K. but I don’t get the call.”

Check that the phone numbers programmed into the EDAC 222-02 are the ones that you want it to call (see function **F11** to **F14 Programming Your Telephone/Pager Numbers**). Also check that the **call type** is correct i.e. you have set the EDAC 222-02 to call a telephone **or** a pager.

“The EDAC 222-02 is set up to call my cell phone. If I’m out of range or my phone is switched off will I get charged for all the calls the EDAC 222-02 makes but I don’t get?”

Yes you will. Care is advised when configuring the EDAC 222-02 to call a cell phone. It is strongly advised to put a limit on the number of calls the EDAC 222-02 can make. Use function **F56 Call Counters**, so that if your cell phone is out of range or switched off, the EDAC 222-02 won’t make continuous calls, which you will get charged for.

“The EDAC 222-02 won’t let me record any voice messages, or enter any new programming commands. Why not?”

The EDAC 222-02 has two jumpers on the circuit board, which can be positioned to stop accidental changes being made to the unit’s configuration and voice messages. If the memory or voice protection jumpers (J702 and J602) are in the **protect** position, any new parameters you enter, such as phone numbers, will not be stored. This error can be easily detected by watching the numbers being played back for verification. The character display

will either show an  for empty, or the previous numbers will be displayed rather than the newly entered ones. See *Jumper Settings* in the *Specifications* section of the manual for information on jumper settings.

**“The EDAC 222-02 is constantly making calls, even when there is no alarm condition.
What’s going wrong?”**

Check that the setting in function **F52 Physical Input Trigger Configuration** is set correctly for the type of Input trigger you are using. Remember that **normally open** means the EDAC 222-02 will trigger when the contact closes and that **normally closed** means that the EDAC 222-02 will trigger when the contact is opened. Also check the condition of the Input switches/sensors and ensure they are operating correctly.

COMPLIANCE NOTES

NOTICE TO AUSTRALIAN USERS

The ACA requires all equipment to comply with the automatic redialling rate and number limits as stated in its Technical Standards. An automatic redial is two or more call attempts to the same telephone number, which are not initiated by a person.

The automatic redialling limits required by the ACA are:

1. BUSY tone detection enabled – not more than 10 calls to the same number for any trigger occurrence until a space of 30 minutes has elapsed.
2. BUSY signal detection disabled – not more than three calls to the same number for any trigger occurrence until a space of 30 minutes has elapsed.
3. The time between calls to the same number should not be set to less than 30 seconds.
4. If the dial tone detect is disabled (function **F02 Call Progress**) then the device must not make more than three call attempts to the same number (see function **F56 Call Counter**).

You must ensure that your equipment settings do not exceed the above limits. Failure to set the equipment to these values will result in the equipment being operated in a non-compliant manner.

NOTICE TO NEW ZEALAND USERS

This device only responds to Distinctive Alert cadences DA1 and DA2. This means that the EDAC 222-02 will not respond to 'faxability' ring.

Some parameters required for compliance with Telecom's Telepermit requirements are dependent on the equipment configuration settings. In order to operate within the limits for compliance with Telecom's specifications, the equipment shall be set to ensure that:

1. There shall be no more than 10 call attempts to the same number within any 30 minute period for each trigger event and;
2. The equipment shall go on-hook for a period of not less than 30 seconds between call attempts to the same number.

This equipment shall not be set up to make automatic calls to the Telecom 111 Emergency Service and should not be used under any circumstances which may constitute a nuisance to other Telecom customers.

In the event of any problem with this EDAC 222-02 it should be by-passed by disconnecting the auto-dialler. The user is to arrange with the supplier of the EDAC 222-02 to make the necessary repairs. Should the matter be reported to Telecom as a wiring fault and the fault be proven to be due to this product, a call-out charge will be incurred.

GLOSSARY

Acknowledged or cancelled When the EDAC 222-02 is active (in alarm state) the unit will make alarm notification calls. When these active trigger states (Inputs) have all been acknowledged the EDAC 222-02 is said to be in a cancelled state. This means that the EDAC 222-02 will not make any further calls. The Input is still present however and it must be removed in order to re-trigger the EDAC 222-02.

Active The EDAC 222-02 is active when an Input has been triggered. This will cause the unit to make alarm notification calls.

Alpha-Numeric pager This is a pager that can display messages with words in them e.g. 'Boiler 2 alarm'.

Call type The type of call being made by the EDAC 222-02 to the user. This will be a voice call, pager or text message.

Cancelled or acknowledged When the EDAC 222-02 is active (i.e an Input has been triggered) the unit will make alarm notification calls. Once these Inputs have all been acknowledged the EDAC 222-02 is said to be in a cancelled state. This means that the EDAC 222-02 will not make any further calls. The Input is still present however and it must be removed in order to re-trigger the EDAC 222-02. Any new trigger on a different alarm Input will initiate a new alarm notification call sequence.

Cleared or idle The Input is cleared when it no longer meets the Input criterion e.g. trigger on closed contact and the contact is open. The EDAC 222-02 is idle when all Inputs are clear (i.e. no Inputs present).

Event A user-defined occurrence that causes the EDAC 222-02 to trigger, such as a fault or change in the state of the equipment being monitored.

Idle When the EDAC 222-02 is not acting on any Input it is said to be idle, normal or in RUN mode.

Input The Input is the physical event that triggers the EDAC 222-02 to make alarm notification calls. Outputs control external devices whereas Inputs trigger the EDAC 222-02.

Latching Once triggered, the Input will remain in the alarmed state until acknowledged by the operator, regardless of the physical Input going back to its normal state.

Normally Closed (N.C) *Opening* the connection between the Input and Gnd will trigger the dialler.

Normally Open (N.O) Connecting the Input to Gnd will *Close* the connection, and trigger the dialler.

Numeric Pager Pager that can only display numbers or codes

Parameter A value that must be entered by the user such as a PIN number or phone number.

Trigger When the input criteria is exceeded (e.g. trigger on contact closure) the EDAC 222-02 is triggered and will proceed to make calls until the EDAC 222-02 is either cancelled or cleared.

WARRANTY

EDAC Electronics Limited ("EDAC") warrants its equipment against defects in materials or workmanship. The term of this warranty shall be as stated in the Contract of Sale for such equipment. Absent any such statement in the Contract of Sale, the term of this warranty shall be one year from the date of initial sale. This warranty only applies to the original purchaser. It does not apply to pre-used equipment.

This warranty is void in any of the following circumstances: (a) The equipment has been misused, neglected, damaged or abused. (b) The equipment has been improperly installed, operated, repaired or maintained. (c) The equipment has been modified. (d) The equipment has been connected to other equipment with which it is not compatible. (e) The equipment has been stored in conditions outside its electrical or environmental specifications. (f) The equipment has been used for purposes other than for which it was designed. (g) The equipment has been used outside its stated specifications and operating parameters.

Unless otherwise provided in a contract of sale, correct installation is the owner's responsibility. EDAC shall not be liable if the equipment has been altered, damaged or rendered non-functional through incorrect installation.

EDAC does not warrant any modules or components manufactured by third parties. However, EDAC shall extend to the owner, in so far as practicable, the benefit of any warranties that such third party manufacturers may have given to EDAC concerning such modules and components.

To assert a warranty claim, complete EDAC's Return Materials Authorisation form ("RMA form"). An RMA form is available from EDAC or its authorised service agent. If EDAC accepts the warranty claim, it shall instruct the owner to return the equipment either to EDAC or its authorised service agent. Wherever possible, use the original packaging to return items. EDAC may request proof of purchase.

If EDAC accepts the warranty claim, EDAC will provide, or arrange for, service, repair or replacement as EDAC shall determine in its sole discretion. EDAC shall bear the cost of such service, repair or replacement. The owner shall bear the cost of freight and insurance on the equipment to EDAC or its authorised service agent, as the case may be. EDAC shall bear the cost of freight and insurance to return the equipment to the owner.

EDAC's sole responsibility is to repair, replace or service equipment subject to a valid warranty claim. Under no circumstance will EDAC be liable for direct, indirect, incidental, special or consequential costs or damages, including dismantling and re-installation costs, loss of operations or profits, to the maximum extent permitted by law.

EDAC accepts no liability for personal injury or property damage resulting from failure to heed relevant operating and safety procedures specified by EDAC or imposed by law.

This is an express warranty. EDAC disclaims any other express or implied warranties, including warranties of merchantability or fitness for purpose, to the maximum extent permitted by law.

Some jurisdictions do not allow limitations or disclaimers of implied or statutory warranties. Some jurisdictions do not allow disclaimers or exclusions of consequential or incidental damages. Therefore, the above disclaimers, limitations and exclusions may not apply in all jurisdictions in which EDAC sells its equipment.

This warranty gives the owner specific legal rights. The owner may have other rights or remedies pursuant to the laws in its territory. Nothing in this limited warranty should be construed as limiting or restricting any other statutory right or remedy of the owner, except for such limitations or restrictions herein as may be allowed by the law of the territory.

EDAC has a policy of continual product improvement and specifications are subject to change without notice.

INTERNATIONAL CONTACT DETAILS

New Zealand

EDAC Electronics Ltd
31 Leslie Hills Drive
P.O. Box 80033
Riccarton
Christchurch
New Zealand

Telephone: +64 3 341-5166
Facsimile: +64 3 341-5176
Email: sales@edacelectronics.com
Web: <http://www.edacelectronics.com/>

Australia

EDAC Electronics Aust Pty Ltd
Suite 6, 173 Boronia Rd
Boronia
Vic. 3155
Australia

Telephone: +64 3 9762-6244
Facsimile: +64 3 9762-6255
Email: billk@edac.com.au
Web: <http://www.edac.com.au/>