



Electronic Data Acquisition and Control

# **EDAC 400-02**

## **AUTO ALARM DIALLER**

### **USER MANUAL**

#### **12 VOLT DC PSU**

**For Firmware from V3.4.3**

© 2004 EDAC Electronics Ltd  
Document Version 1.6

**[www.edacelectronics.com](http://www.edacelectronics.com)**

<b>INTRODUCTION.....</b>	<b>3</b>
<b>SPECIFICATIONS .....</b>	<b>4</b>
<b>INSTALLATION .....</b>	<b>6</b>
Installation Requirements .....	6
Telephone Line Connection.....	8
Wall Socket Installation.....	8
<b>HOW THE EDAC 400-02 WORKS .....</b>	<b>9</b>
Run Mode .....	9
Making Alarm Notification Calls .....	9
Cancelling Alarm Notification Calls.....	10
<b>INTRODUCTION TO PROGRAMMING YOUR EDAC 400-02.....</b>	<b>11</b>
Introduction – Program Mode .....	11
Explanation of prompts – Program Mode .....	11
Entering Programming Mode.....	11
Programming Example .....	11
The * Key - Program Checking .....	12
Exit to RUN Mode .....	12
Restore Factory Defaults .....	12
<b>GETTING STARTED QUICKLY - Example .....</b>	<b>13</b>
Entering Programming Mode.....	13
Programming Telephone Numbers.....	13
Recording a Site Message.....	13
Replaying the Recorded Message.....	14
Exit to Run Mode .....	14
Testing the EDAC 400-02.....	14
<b>PROGRAMMING – GLOBAL PARAMETERS.....</b>	<b>15</b>
Function F00 Modify PIN Number .....	15
Function F02 Call Progress .....	15
Function F03 Ring-back Trigger Cancellation .....	16
Function F04 Answer Incoming Calls When any Input Active .....	16
Function F05 Answer Incoming Calls When all Inputs are Cancelled .....	17
Function F06 Answer Incoming Calls When no Inputs Active (Idle) .....	17
Function F07 Call List Priority & Rosters .....	18
Function F08 Outputs .....	19
Function F09 Trigger/Dial Time .....	19
Function F96 Trigger/Dial Mode .....	20
Function F99 Send Model Information via RS232 .....	20
<b>PROGRAMMING – RECORDING VOICE MESSAGES.....</b>	<b>21</b>
Function F0* Recording Voice Messages.....	21
RECORD example.....	22
PLAY example .....	22
<b>PROGRAMMING – INPUT SPECIFIC PARAMETERS.....</b>	<b>23</b>
Function F10 Programming Your Pager Messages.....	23
Function F11 Programming Your Telephone/Pager/SMS Numbers.....	23
Call Types.....	24
Function F15 Programming an SMS/Paging Access Number .....	25
Function F51 Setting Inputs to Trigger or Report .....	26
Function F52 Physical Input Trigger Configuration.....	26
Function F53 Wait Time Between Calls.....	27
Function F54 Pager Delay Time .....	28
Function F55 Message Play Time .....	28

Function F56 Call Counter.....	29
Function F57 SMS/Paging Service Password .....	29
Function F58 SMS/Paging Service ID .....	30
<b>PROGRAMMING – JUMPER SETTINGS .....</b>	<b>31</b>
<b>APPLICATION NOTES.....</b>	<b>32</b>
Using Outputs .....	32
Using Paging .....	33
Numeric Pager.....	33
Alpha-Numeric pager/Text messaging (SMS) .....	33
Modem Communications .....	35
Programming Using RS232 .....	35
<b>FREQUENTLY ASKED QUESTIONS .....</b>	<b>36</b>
<b>COMPLIANCE NOTES.....</b>	<b>37</b>
NOTICE TO AUSTRALIAN USERS .....	37
NOTICE TO NEW ZEALAND USERS.....	37
<b>GLOSSARY .....</b>	<b>38</b>
<b>WARRANTY .....</b>	<b>39</b>
<b>INTERNATIONAL CONTACT DETAILS .....</b>	<b>40</b>

## INTRODUCTION

---

The EDAC 400-02 is a cost-effective, auto reporting dialler designed for industrial, domestic and small-business use. The EDAC 400-02 is an effective tool for alerting the user to events such as faults or changes in equipment state. It is physically compact, consumes little power and can be installed very quickly. Its ease of programming combined with simple installation make it highly attractive and cost effective in monitoring applications.

The EDAC 400-02 is activated by a contact closure, or opening, which results in the start of a user-defined dialling sequence, followed by the transmission of either an 8-second voice message or a 20-character pager/SMS message (subject to network availability).

When an event triggers the auto-dialler, the EDAC 400-02 will make an alarm notification call. The EDAC 400-02 will pick up the phone line and call a list of people via telephone, cell phone or pager. The EDAC 400-02 speaks the pre-recorded message announcing the problem.

Upon receipt of an alarm call you may reset the EDAC 400-02 by simply pressing a numeric digit on your telephone keypad or by entering a user-defined PIN number. This will stop the unit making further alarm notification calls. Alternatively, the EDAC 400-02 may be interrogated by calling into it and listening to the voice message. This provides the opportunity to cancel/acknowledge the alarm inputs via the telephone keypad. This option would normally be used when the EDAC 400-02 is operating in conjunction with a pager and/or SMS messaging. Other options, such as Outputs, are user programmable either on site or remotely (via a telephone).

Once the EDAC 400-02 is in a cancelled state, the EDAC 400-02 will suspend its dialling sequence and remain cancelled until the event that triggered the alarm has been removed (cleared). If the EDAC 400-02 does not receive acknowledgment of an alarm, it will remain in dialling mode until the event that triggered the alarm is cleared, or the user-defined call count limit is reached.

All telephone numbers, messages, and functions are user programmable via a keypad and a single character display.

The EDAC 400-02 has numerous programmable features that enable it to be a flexible telemetry monitoring tool suitable for use in any situation. If you require information about the EDAC 400-02 and how it can be used with your monitoring application, please contact your supplier. For online manuals for all EDAC products, use the EDAC web site <http://www.edac.com.au>.

## SPECIFICATIONS

---

### Connections

1.5 mm screw terminals are provided for all electrical connections to the EDAC 400-02.

### Power

- Voltage 10-15V DC
- Current 40mA idle 80-100mA active

**NOTE: Power supply should comply with Telecom PTC101 requirements if dialler is to be connected to Telecom NZ network and ACA requirements if dialler is to be connected in Australia. (Such as EDAC PS12)**

### Inputs

Four, clean-contact, voltage-free trigger inputs such as relay contacts, a float switch or a micro switch are required.



***WARNING: Applying voltage to the Inputs of the EDAC 400-02 may damage the EDAC 400-02 and will void the product warranty.***

### Outputs

Up to four Outputs by jumper selection. Open collector type. Maximum current is 120mA per output. Each Output takes up one input channel.

### Telecom Line

Two RJ11 sockets. A suitable cord can be provided compatible with the wall socket in your country. The inner two pins of the RJ11 socket are used for TIP + RING.

### RS232 Connector (DB9)

Used for programming EDAC 400-02 configuration via Hyper Terminal and a PC. See section 'Programming using RS232' in 'Application Notes' for detailed instructions. Alternatively it can be plugged into a PLC/RTU or SCADA system, allowing the unit to provide a 2400 baud modem connection to an external device.

### Mechanical

- Dimensions 192mm length x 110mm width x 35mm height.
- Weight 250gm
- Cabinet Aluminium base with screw on (M4 pozi-drive) aluminium lid.
- Finish White epoxy powder coat.
- Mounting 4 x 4mm mounting holes in the base of the cabinet.
- Line in/Line out RJ11 standard (only the 2 inner pins are used as Tip + Ring).

### Messages

- Site Message Four seconds of high-quality, user-recordable speech.
- I/O Messages Eight seconds of high-quality, user-recordable speech per I/O.
- Acknowledged Four seconds of high-quality, user-recordable speech to identify when message inputs have been acknowledged.
- Idle Message Four seconds of high-quality, user-recordable speech to identify when the EDAC 400-02 inputs are in an idle state.

### Parameters

- Maximum number of telephone numbers Four per Input or one list of 16 numbers
- Maximum number of digits per number Twenty including pauses
- Time duration of phone call (playtime) Variable 1 - 9 minutes
- Wait time (between each call) Variable 0 - 9 minutes.
- PABX access delay Two seconds for each user inserted pause
- Recordable message time Up to eight seconds per Input
- Dialling mode DTMF (tone dialling)

### **Numeric Paging**

Twenty-digit numeric strings can be transmitted to a Numeric Pager to identify the site and active input trigger. Numeric paging can be configured via the EDAC 400-02 keypad.

### **Alphanumeric Paging**

Multiple paging hosts can be used. A different host can be assigned to each Input trigger.

- Paging host protocol TAP
- Pager messages 20 characters per Input (i.e. 4 messages)
- Max number of pagers 16
- Host password User programmable
- Host ID User programmable (default PG1)

### **Modem**

The EDAC 400-02 has an onboard 2400 baud V22bis modem (backward compatible with 1200 V22 connections) used for alphanumeric paging and remote configuration using Hyper Terminal. The EDAC 400-02 can also be put into transparent mode. This allows remote communications via a dial-up connection, to devices attached to the external RS232 connector such as a PLC or RTU.

### **Programming**

Functions (including voice), are normally programmed using the keypad and single character display. The EDAC 400-02 can also be programmed through the inbuilt RS232 connector and Hyper Terminal; a Windows based application shipped with all versions of Windows. See section '*Programming using RS232*' in '*Application Notes*' for detailed instructions.

### **Alarm Cancellation**

Alarm notification calls can be cancelled by using a DTMF touch-tone phone. The alarm can be cancelled by pressing any numeric key on your telephone keypad or by entering a PIN, depending on which option you have selected at the time of installation and programming.

# INSTALLATION

## Installation Requirements

The typical wiring schematic is shown in Figure 1.

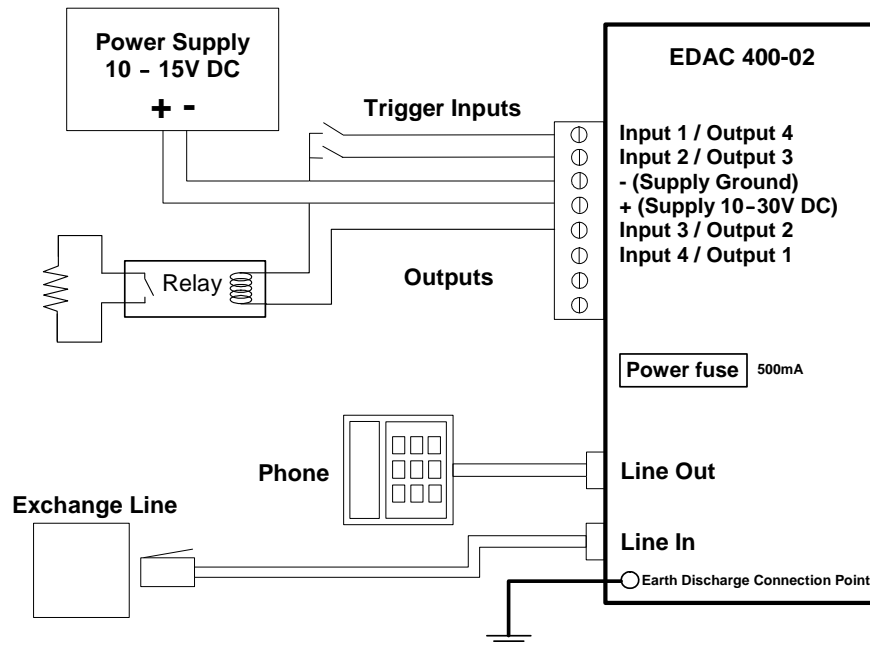

Figure 1: Typical EDAC 400-02 Installation

- **Power Supply**

A DC regulated power supply complying with Telecom PTC101 or ACA regulations is required (such as EDAC PS12). The DC power supply should be normally constant, between 10 and 30 volts. An optional battery backup power supply (EDAC PS12) is required to maintain operation during a mains failure event.

- **Input Triggers**

The input trigger causes the EDAC 400-02 to commence the dialling sequence. A clean contact, voltage-free input is required. This would normally be via an external relay or switch. The EDAC 400-02 is configured by default for a normally open type input. Alternatively the user can configure any of the inputs to accept a normally closed type input (see function F52). Some examples of these types of triggers might be a relay output, a micro-switch or a float switch. Any of the inputs can be configured as either an input or an output (see function F08).



**NOTE: The activating trigger must be installed correctly and maintained to prevent false triggering.**

- **Earth Discharge**

The EDAC 400-02 has a separate Earth Discharge Circuit, which is used to protect the EDAC 400-02 and any attached equipment from lightning strikes and other external high voltage transients, which may travel down the phone line. The Earth Discharge circuit must be connected to a common earth point. These are usually found at a switch board earth point (earth buss bar). The Earth Discharge should be connected using a M3 ring terminal to the bottom right PCB screw (near phone/line sockets).

- **Telephone Line**

The EDAC 400-02 does not require a separate line and can be inserted as a master upstream device in an existing telephone connection (see Secure Installation on next page). An RJ11 plug and socket system is used. You must use the cord-set provided to connect the EDAC 400-02 to the Telecom wall socket or the EDAC 400-02 may not work and no alarm notification calls will be made. Extra cords are available upon request for a small charge. The EDAC 400-02 may be used with a PABX (Private exchange) but it must be connected to an analog line.



---

**WARNING: If the existing phone system has lights on the phone it is probably a digital PABX system.**

**Do not plug the EDAC 400-02 into a digital phone system unless you are sure that it supports standard analog phone equipment. Plugging the unit into an incorrect phone system will cause severe damage to the equipment and void the warranty. If there is any uncertainty please contact the supplier where you purchased your PABX for more information.**

---

**Points to Note:**

- The EDAC 400-02 can be connected between the telephone line (trunk) and the PABX or it can be used on an extension.
- When connected to a PABX and an extension, ensure that the extension socket the EDAC 400-02 is plugged into remains active during a power failure. Refer to your PABX instructions or contact your supplier.

## Telephone Line Connection

The following schematic diagrams show typical EDAC 400-02 phone line installations:

### Wall Socket Installation

Figure 2 shows a typical single wall socket installation and requires two telephone-related connections. Other telephones left off-hook may prevent the EDAC 400-02 from making calls.

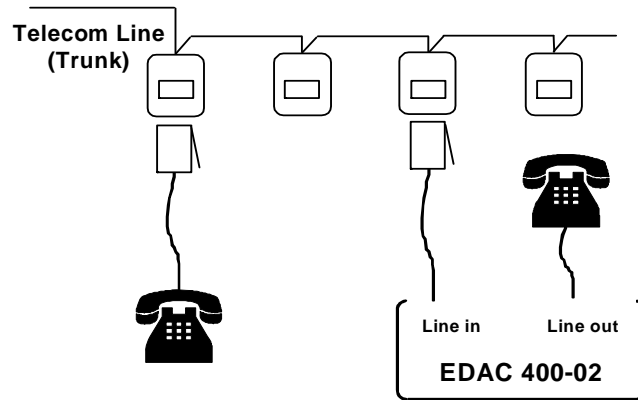

Figure 2: Wall Socket Installation

### Secure Installation

This is a master upstream device configuration and may require Telecom assistance to remove the connection between the first wall socket and other wall sockets, as shown below. On an alarm input trigger, the EDAC 400-02 takes over the telephone line, disconnecting all other calls. The alarm condition is immediately acted on and cannot be stopped by unauthorised means. When not triggered, the EDAC 400-02 has no effect on the phone line.

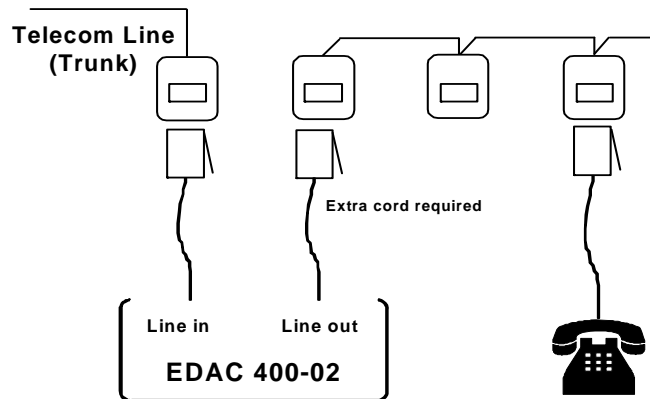



Figure 3: Secure Installation

## HOW THE EDAC 400-02 WORKS

---

### Run Mode

On power-up, the EDAC 400-02 will be in RUN mode assuming no trigger is present. RUN mode can be identified by a horizontal line on the display with a flashing dot. 

The EDAC 400-02 uses three distinct states when in RUN mode:

#### Active

When the EDAC 400-02 is active (in alarm state) the unit will make alarm notification calls.





#### Cancelled or acknowledged

When the EDAC 400-02 is active (in alarm state) the unit will make alarm notification calls. When these active trigger states (inputs) have all been acknowledged the EDAC 400-02 is said to be in a cancelled state. This means that the EDAC 400-02 will not make any further calls. The input is still present however and it must be removed in order to re-trigger the EDAC 400-02. Any new trigger on a different alarm input will initiate a new alarm notification call sequence.

#### Cleared or Idle

The input is cleared when it no longer meets the input criteria (e.g. trigger on closed contact and the contact is open). The EDAC 400-02 is idle when all inputs are clear (i.e. no inputs present).

These states can normally be identified by the following symbols on the display.

-  = **Cleared or Idle** (default at power up)
-  = **Active** (Looking for dial tone / dialling)
-  = **Active** (Call connected, speaking / sending messages)
-  = **Active** (In retry loop, waiting to make next call)
-  = **Cancelled or acknowledged** (EDAC 400-02 cancelled)

### Making Alarm Notification Calls

When an event triggers an alarm notification call, the EDAC 400-02 will dial through the telephone number call list. When the call is answered, the voice message is spoken or the pager message sent. This process is broken down into the following stages:

1. All inputs are idle (no alarms are being triggered).
2. An input meets the alarm-trigger criteria (see functions F51 and F52).
3. The EDAC 400-02 waits for the trigger/dial time to elapse (the time between the alarm trigger and the first phone call being made). If the input is removed before the EDAC 400-02 has had time to place a call the input state goes back to idle unless the input is set to latch. (see functions F09, F52 and F96)
4. The EDAC 400-02 will now make calls to the people on your call list (see functions F07 and F11).

When a call is answered and it is a voice call (telephone, cell/mobile phone, etc) it will speak the message sequence outlined below.

- Your site message (identifies the site)
- The Input messages (identifies which alarms have been triggered)
- The cancellation message (if you cancel the alarms) "The following Inputs have been acknowledged"
- The Input messages again (if the alarms are cancelled but the Input triggers have not been removed)
- The site message is repeated at the end of the message sequence.

This message sequence will be spoken repeatedly for whatever length of time you have set for *'Function F55 Message Play Time'*.

Once the message play time (see *'Function F55 Message Play Time'*) has been reached, the EDAC 400-02 will hang up the call. The EDAC 400-02 now waits for the time programmed in *'Function F53 Wait Time Between Calls'* before making the next call in the call list (function F53).

An 'r' will be displayed indicating the dialler is in a retry state.

On receiving an alarm notification call, you should acknowledge (cancel) the alarm by pressing any key or entering the PIN number. This will stop the EDAC 400-02 from making more calls. If the EDAC 400-02 hangs up before you have time to cancel, you can dial into the unit to cancel it (functions F03, F04, F05 and F06 to set cancellation options).

## **Canceling Alarm Notification Calls**

When the EDAC 400-02 is cancelled or acknowledged it will stop trying to make alarm notification calls. An alarm notification call is cancelled by one of three ways:

- User Acknowledgement by key-press on telephone
- User Acknowledgement by calling into EDAC
- Self-Cancel by counting calls.

### **User Acknowledgement by key-press on telephone**

If you receive a call from the EDAC 400-02 and wish to acknowledge (cancel) the call, stopping further calls being made, press the any numeric key (0-9) on your telephone keypad while the alarm message is playing. The option of cancelling using a PIN can be set in *'Function F11 Telephone Pager Numbers'*.

The EDAC 400-02 will respond with beeps to confirm it has received your key presses and then announce which inputs have been acknowledged. At this point, user may hang up their telephone. No other calls will be made by the EDAC 400-02 until a new trigger signal occurs.

If you do not wish to acknowledge the alarm, press the # key to make the EDAC 400-02 hang up and call the next number in its call list.

If you have acknowledged the alarm, pressing # will put the EDAC 400-02 into modem mode (you will hear fax tones). Hang up your phone – the EDAC 400-02 will automatically time-out and stop making further calls.

Pressing \*0# will acknowledge the call and make the EDAC 400-02 hang up immediately. No further alarm notification calls will be made.

### **User Acknowledgement by calling into EDAC**

This method is normally used to allow the EDAC 400-02 to be cancelled after receiving a call on your pager. It can also be used if the EDAC 400-02 hangs up before you have time to cancel. Go to a telephone and ring the telephone number of the EDAC 400-02. The EDAC 400-02 will answer and play messages to announce its current status. You may cancel (if allowed) by pressing any key on your phone or entering your PIN on your telephone keypad

### **Self-Cancel by counting calls**

When the number of calls set in *'Function F56 Call Counter'*, is reached, the alarm condition is cancelled and the EDAC 400-02 will not make any further calls.

## Introduction – Program Mode

In order to program phone numbers, voice messages and other parameters into the EDAC, it must be put into 'Program Mode'. In this mode the EDAC is ready to store entered parameters for use later when in 'Run Mode'. The EDAC uses a series of key sequences and prompts to enter parameters. These are explained below

## Explanation of prompts – Program Mode



The 'F' prompt indicates the EDAC 400-02 is in programming mode and is waiting for you to select a function.



The 'P' prompt indicates that a function ('F') has been selected and the EDAC 400-02 is awaiting parameter ('P') entry for this function.



The 'E' prompt indicates the EDAC 400-02 has detected an error in the data entry process, or a function is empty. Note that the 'E' is also displayed for the number 12 in some functions.



The 't' prompt indicates the EDAC 400-02 is waiting for you to enter a call type. The seven-segment display cannot create a 't' character but the picture above is an accurate diagram of this prompt.



The 'r' prompt indicates that a voice message is recording.

## Entering Programming Mode

Press **1234** (The factory default PIN number)

The 'F' prompt will appear on the display.

If your PIN is not working, turn the EDAC 400-02 off and hold down a key while powering up. The product will first display the firmware version (e.g. 3.5.3.) then go into programming mode and display the 'F' prompt.

## Programming Example

Below is an example of a prompt and key-press sequence for setting the call progress function. Programming of all functions in the EDAC follows a very similar sequence. The large segment



characters represent prompts on the display of the EDAC. The key type characters (abc) represent input from the user on the keypad.

The example below will set the Call Progress function (F02) to 'dial tone detect only'. (P1)



⇒

02

⇒



⇒ 1

Call Progress

Dial tone detect only.

The EDAC will often play back any user entry on the display so the user can check the correct value was entered. The EDAC will always return to the 'F' prompt when an entry sequence is complete.

## The \* Key - Program Checking

The \* key is used to display current parameter data held in the EDAC 400-02. Select a function and, when the 'P' is displayed, press the \* key. The data currently held in that function will display (digit by digit in the case of multi-digit entries).

## Exit to RUN Mode

Once all the functions have been programmed, exit programming mode by pressing ## very quickly at the 'F' prompt. The EDAC 400-02 should now display the  with a flashing dot. In RUN mode the EDAC 400-02 is ready to accept an input trigger and make alarm notification calls.

 ⇒ ## = Exit programming to RUN mode.

## Restore Factory Defaults

Use this function to clear old or unknown parameters (user settings) and return to factory settings. You can then reprogram each function from the default starting point

---

**NOTE:** *This procedure does not affect any existing voice messages.*

---



**WARNING:** *The following instructions will clear your user settings from all functions associated with an input, e.g. #1 will clear the phone/pager numbers, trigger type, wait time, message play time and call counter for input one. If you wish to reset only one or two functions, look up those functions in this manual and simply reprogram the data.*

---

 ⇒ #0 = Clear general parameters (functions **F01** to **F09**).

#1 = Clear phone numbers and all parameters for Input 1.

#2 = Clear phone numbers and all parameters for Input 2.

#3 = Clear phone numbers and all parameters for Input 3.

#4 = Clear phone numbers and all parameters for Input 4.

## GETTING STARTED QUICKLY - EXAMPLE

---

Below is a brief description of how to quickly set up the essential functions of the EDAC 400-02. This simple configuration example will take you through the steps needed to:

- Program one telephone number for your alarm notification call list.
- Record one voice message to identify the site (location of the alarm).
- Record one voice message to report the alarm condition.
- Replay the recorded voice message so you can check it.
- Apply a physical trigger to any input (1-4) to initiate an alarm notification call and test that the unit is working.

### Entering Programming Mode

Press **1234** (the factory default PIN number).



The 'F' prompt will appear on the display.

If your PIN is not working, turn the EDAC 400-02 off and hold down a key while powering up. The product will go into programming mode and display the 'F' prompt.

### Programming Telephone Numbers

There are a number of phone number storage options with a maximum of 16 different numbers. For full instructions on how to program telephone numbers, refer to '**F11 Programming Your Telephone / Pager / SMS Numbers**' and '**F07 Call List Priority and Rosters**' for full instructions

To enter phone or PABX extension number **one**:

 ⇒ 11 ⇒  ⇒ Enter number followed by a # to save  
e.g.  
**0243256#**

Then



⇒  ⇒ Enter the call type **1** (This means voice call, cancel using any key).

The EDAC 400-02 will then redisplay the entered telephone number followed by the call type so that you may verify their accuracy.

The dialler will return to the 'F' prompt.

### Recording a Site Message

When recording voice messages speak clearly into the microphone located inside the lid in the top left hand corner of the circuit board.

 ⇒ 0\* ⇒  ⇒ 0 ⇒ # = Recording starts as soon as the # key is pressed.

Press any key to finish the recording.

⇒  Press any key to finish recording ⇒ The message will then play until any key is pressed.

Press any key again and the dialler will return to the 'F' prompt.

## Recording Input Trigger one Voice Message

 ⇒ 0\* ⇒  ⇒ 1 ⇒ # = Recording starts as soon as the # key is pressed.



⇒  ⇒ The message will then play until a key is pressed.

Press any key to finish the recording.

Press any key again and the EDAC 400-02 will return to the 'F' prompt.

See function **F0\*** for the full list of voice message functions.

## Replaying the Recorded Message

 ⇒ 0\* ⇒  ⇒ 1 ⇒ \* = Playback starts as soon as the \* key is pressed.

⇒  ⇒ The message will then play until any key is pressed.

The EDAC 400-02 will return to the 'F' prompt when complete.

## Exit to Run Mode

 ⇒ ## = Exit programming to RUN mode.

Once all these functions have been programmed, exit programming mode by pressing ## very quickly at the 'F' prompt. The EDAC 400-02 should now display the  with a flashing dot. In RUN mode the EDAC 400-02 is ready to accept an input trigger and make alarm notification calls.

## Testing the EDAC 400-02

By default the input is set up for **normally open**. Connecting the input terminal to negative supply will trigger the EDAC 400-02.

Ensure the EDAC 400-02 is connected to an analog phone line. Use a paper clip or small piece of wire to connect any input to **ground** (third terminal from the left). This will make a closed connection, causing the input to trigger and the EDAC 400-02 to make an alarm notification call.

# PROGRAMMING – GLOBAL PARAMETERS

---

## Function F00 Modify PIN Number

The factory default PIN is 1234. If you forget the PIN you can still enter programming mode by holding down any key when applying power to the EDAC 400-02.

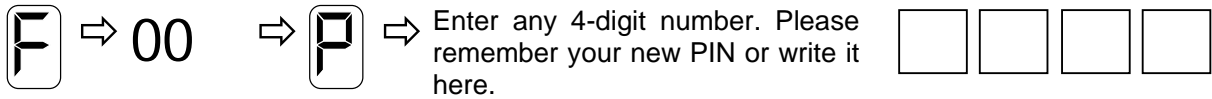

Default: 1234

## Function F02 Call Progress

This Function determines if the EDAC looks for dial and/or ring tone when making an alarm notification call. It also uses this setting to determine if a call has been successful or not. For the call counter to be incremented the call must be successful, therefore the conditions of this function must be met.

For example if 'Dial tone Detect only' is used the EDAC must detect dial tone for a successful call to be made and for the call counter to be incremented.

Using **dial tone detection only** is recommended.

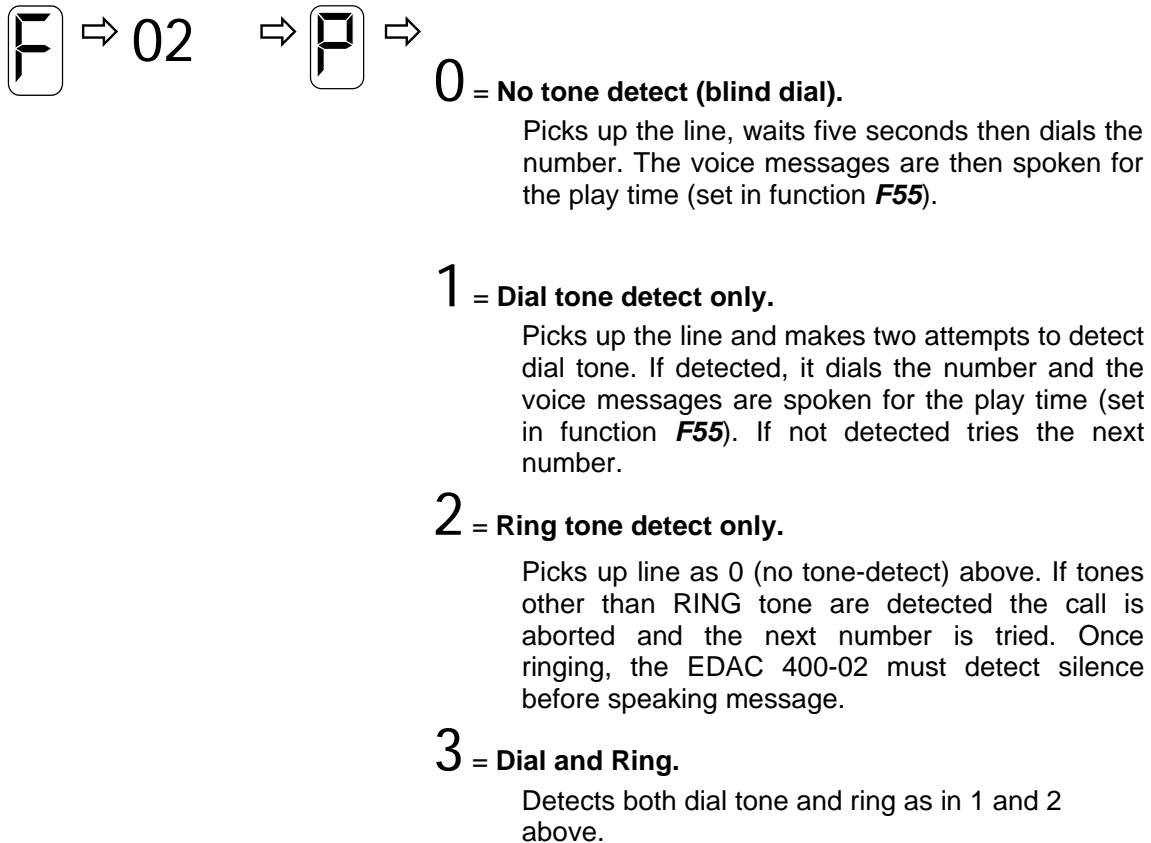

Default: 1 (Dial tone only)

**Note:** Please see section 'Compliance Notes' on page 38

### **Function F03 Ring-back Trigger Cancellation**

When an input is active, the dialler will attempt to make calls. If the input (see F53) allows a **wait time between calls** and the dialler will **answer incoming calls** (also see F04, F05, and F06). The caller may then cancel the input (as below).

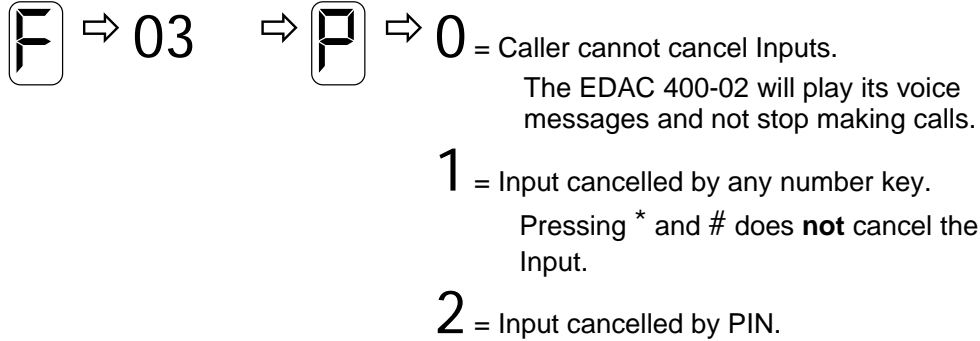

Default: 1 (Cancel by any number key)

### **Function F04 Answer Incoming Calls When any Input Active**

When an input is active the EDAC 400-02 will attempt to make alarm notification calls. Setting a wait time (function **F53**) gives you the opportunity to call into the EDAC 400-02 and cancel the input. When an input is cancelled, the alarm condition still exists but the EDAC 400-02 will stop making alarm notification calls.

The EDAC 400-02 will only use this function and its setting when any input is active.

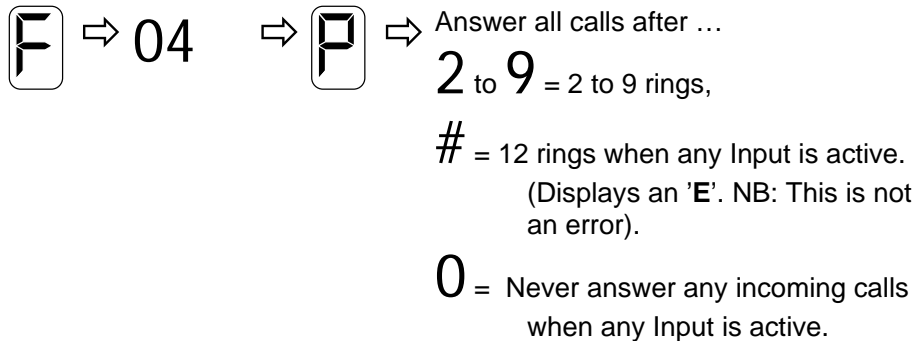

Default: 4 (Answer after four rings when any Input active)

### **Function F05 Answer Incoming Calls When all Inputs are Cancelled**

When an Input is cancelled, the alarm condition still exists but the EDAC 400-02 will stop making alarm notification calls. If you wish to monitor the status of an alarm you can call into the EDAC 400-02 periodically and listen to its message. Monitoring Input (alarm) status can be useful as certain alarm conditions may go away by themselves e.g. electrical power will be automatically restored after a power failure. In this instance the alarm condition is removed automatically and the EDAC 400-02 will reset itself to the idle state.

The EDAC 400-02 will only use this value when all active Inputs are cancelled but not removed.

**F** ⇒ 05 ⇒ **P** ⇒ Answer all calls after ...  
2 to 9 = 2 to 9 rings.  
# = 12 rings when all active Inputs  
are cancelled.  
0 = Never answer any incoming  
calls when all active Inputs are  
cancelled.

Default: 4 (Answer call after four rings)

### **Function F06 Answer Incoming Calls When no Inputs Active (Idle)**

You may wish to periodically dial into the EDAC 400-02 to confirm that it is in idle state. This can be useful if you have previously received a notification call of an alarm which may cancel itself e.g. electrical power will be automatically restored after a power failure. Because the alarm condition is removed, the EDAC 400-02 will reset itself to the idle state.

The EDAC 400-02 will use this value only when there are no Inputs active and is in the idle state.

**F** ⇒ 06 ⇒ **P** ⇒ Answer all calls after ...  
2 to 9 = 2 to 9 rings.  
# = 12 rings when idle.  
0 = Never answer any incoming  
calls when idle

Default: 4 (Answer calls after four rings)

---

**NOTE:** *If using Outputs you will need to consider appropriate values for functions **F04**, **F05** and **F06**, to ensure the EDAC 400-02 answers the phone appropriately.*

---

For installations that only use voice alarm notification calls where no user call back is required, functions **F04**, **F05** and **F06** can be set to zero ensuring the EDAC 400-02 will never answer an incoming alarm call. This allows the phone line to be used for other day-to-day activities. This configuration requires that the operator acknowledges the alarm notification call on the phone they receive the call on.

## Function F07 Call List Priority & Rosters

The EDAC 400-02 can be programmed with up to 16 different phone numbers. By default the programmed numbers are treated as a single list of 16 numbers. Using **F07** the list can be divided up in to blocks of 4, or 8 and treated differently depending on the alarm Input trigger number.

The list of telephone/pager numbers can be configured in a number of ways including rosters.

A roster is used to assign a specific call list to be used to call only the people who will be on duty that day. You can use four separate lists of four phone numbers, and change which list is to be used either remotely or on site.

When the call is established and the EDAC 400-02 is speaking the idle message, the current roster may be changed by pressing \* followed by the roster number (1, 2, 3 or 4).

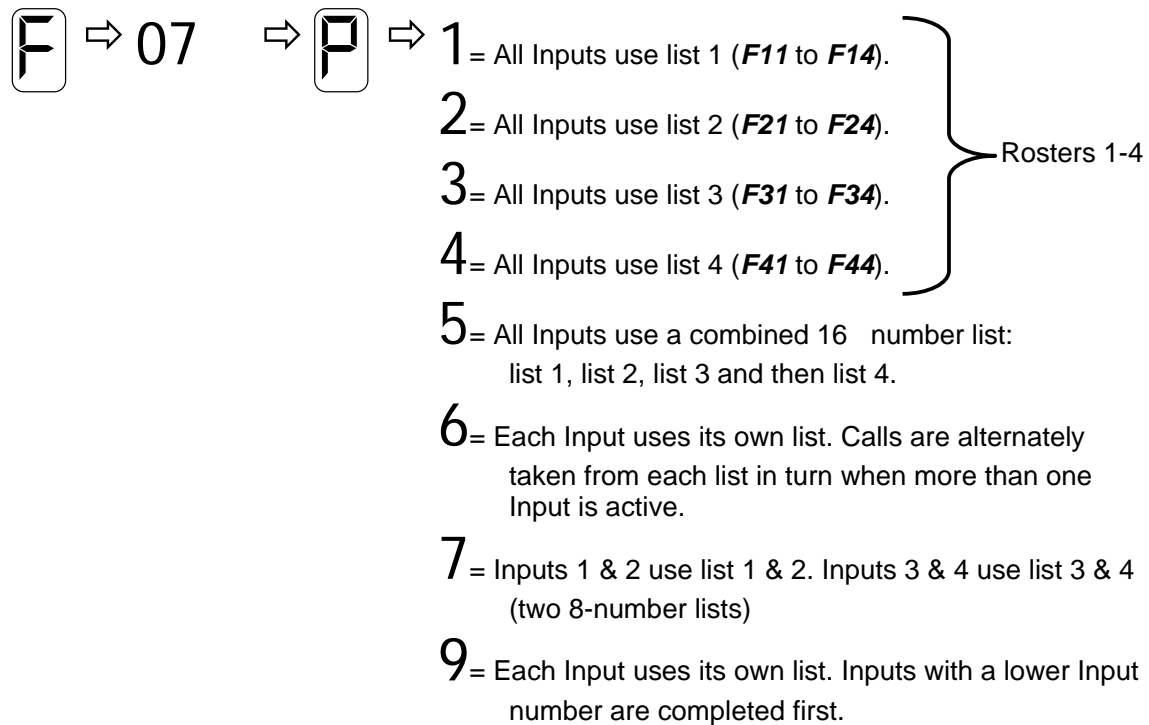

Default: 5 (One list of 16 numbers)

## Function F08 Outputs



All 4 Inputs can be used as pull down (open collector type) Outputs. A physical terminal can be used **either** as an Input or Output but **not** both. Any combination of Inputs and Outputs can be configured. See section *Specifications* for max current and voltage ratings.

These Outputs are independent from any Input and are toggled by a key press once a call is established and a suitable PIN has been entered to gain access to 'Output Mode'. An operator's pre-recorded voice message provides feedback to the operator as to the status of the Output e.g. 'The heater is On' or 'The heater is Off'.

See 'Using Outputs' in the Application Notes section for more information on using outputs

The numbers used to identify Outputs are the opposite of the Input numbers, i.e. Input 4 is Output 1. Please refer to the table below to see which Inputs correspond to which Outputs.

Input 1	Output 4
Input 2	Output 3
Input 3	Output 2
Input 4	Output 1



 ⇒ 08 ⇒  ⇒ 0 = All triggers are Inputs (no Outputs).  
 1 = Output 1 and trigger 1, 2 & 3.  
 2 = Output 1 & 2 and trigger 1 & 2.  
 3 = Output 1, 2 & 3 and trigger 1.  
 4 = All triggers are used as Outputs.

Default: 0 (All Inputs)

## Function F09 Trigger/Dial Time

This function determines the period to wait from physical trigger to alarm condition and dial out. It can be used as a trigger delay timer to allow for exit / entry time, or can be used with float switches to ensure the level has reached and is triggering the float switch correctly.

The **latch** capture, (function **F52**) occurs either when triggered, or at the end of the trig/dial time. The value displayed is seconds by default. Minutes may be used (see function **F96**)

 ⇒ 09 ⇒  ⇒ 0 = Immediate dial (default).  
 1 = 1 sec/min    2 = 2 sec/min  
 3 = 3 sec/min    4 = 5 sec/min  
 5 = 10 sec/min    6 = 15 sec/min  
 7 = 20 sec/min    8 = 30 sec/min  
 9 = 60 sec/min    # = 120 sec/min

Default: 0 (Start dialling when triggered)

## **Function F96 Trigger/Dial Mode**

When an alarm input is present the EDAC 400-02 will trigger. The EDAC 400-02 will not begin calling until the trigger/dial time has passed (see function **F09**). Function **F96** is used to set the units used (seconds or minutes) by the trigger/dial time in **F09**.

When the input is **latching** the input can be latched either at the trigger time or at the dial time (see function **F52**). **Latch on trigger** means once the EDAC 400-02 has been triggered it will continue until it is acknowledged. If the input is set to **latch on dial** and the trigger is removed before the dial has commenced the EDAC 400-02 will cancel and stop making calls. With function **F52** set as non-latching, the latch on trigger and latch on dial have no effect. The trigger dial time is always relevant.

**F** ⇒ 96 ⇒ **P** ⇒ 0 = Latch on trigger & trigger/dial time is in seconds.  
1 = Latch on trigger & trigger/dial time is in minutes.  
2 = Latch on dial & trigger/dial time is in seconds.  
3 = Latch on dial & trigger/dial time is in minutes.

Default: 0 (Latch on trigger & trigger/dial time is in seconds)

## **Function F99 Send Model Information via RS232**

This function makes the EDAC 400-02 send an identification string via the RS232 connector. By using this function from the keypad you can send text to a PC. This is a good way to check if the PC is correctly connected and communicating. You need to be running Hyperterm or a similar terminal emulation program. The text is sent as 1200bps, ASCII 8-bit, no parity, one stop bit.

**F** ⇒ 99 Sends banner text at 1200bps via the RS232 connector.

## PROGRAMMING – RECORDING VOICE MESSAGES

---

### **Function F0\* Recording Voice Messages**

The operator can re-record all voice messages in the EDAC 400-02. Voice messages are recorded on to an analogue EEPROM for permanent storage using the microphone provided inside the lid on the top left hand corner of the EDAC 400-02. The message is played back through the onboard speaker. The Speaker Mute jumper (J600) **must** be in the top most position (un-muted) to hear any message playback. See 'PROGRAMMING - Jumper Settings' for more information.

Jumper J602 is provided to protect your recorded messages in EEPROM from being accidentally erased. At the time of shipping the default position is to the down/bottom (unprotected) position, allowing messages to be re-recorded, for your installation configuration.

---

**NOTE:** You **must** ensure that the voice protection jumper (J602) is in the **down/bottom** position before attempting to record a message or your message will not be recorded.

---

### **Play and Record control keys**

All voice messages start with 0\* this is the function number. After this a 'P' for parameter will be displayed and a parameter must be entered. Use the tables below to select a parameter for the different voice message slots.

- To **start recording** press # after entering the parameter number. Recording starts immediately, and is indicated by an 'r' being displayed. Press any key to finish recording. The message will be played back automatically. Then the 'F' prompt will return.
- To play back a previously recorded message enter 0\* followed by the parameter at the 'P' prompt. Then press \* to hear the message. Press any key to return to the 'F' prompt.

<b>F0*0</b>	Site message (spoken to identify the EDAC 400-02 installation)
<b>F0*9</b>	Idle message ("All Inputs are clear")
<b>F0**</b>	Cancel message ("The following Inputs have been acknowledged")
<b>F0*#</b>	Output mode

<b>Inputs</b>	<b>F0*1</b>	Input 1 alarm message (Eight seconds max)
	<b>F0*2</b>	Input 2 alarm message (Eight seconds max)
	<b>F0*3</b>	Input 3 alarm message (Eight seconds max)
	<b>F0*4</b>	Input 4 alarm message (Eight seconds max)

<b>Outputs</b>	<b>F0*1</b>	Output 4 On message (Four seconds max)
	<b>F0*2</b>	Output 3 On message (Four seconds max)
	<b>F0*3</b>	Output 2 On message (Four seconds max)
	<b>F0*4</b>	Output 1 On message (Four seconds max)
	<b>F0*5</b>	Output 4 Off message (Four seconds max)
	<b>F0*6</b>	Output 3 Off message (Four seconds max)
	<b>F0*7</b>	Output 2 Off message (Four seconds max)
	<b>F0*8</b>	Output 1 Off message (Four seconds max)

### RECORD example

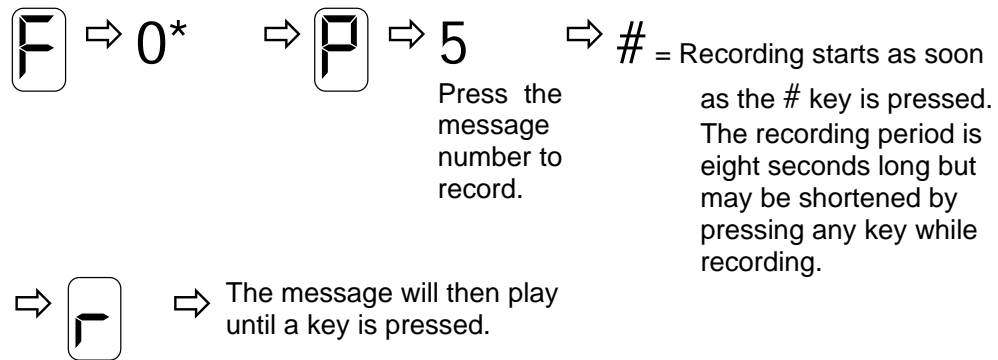

### PLAY example

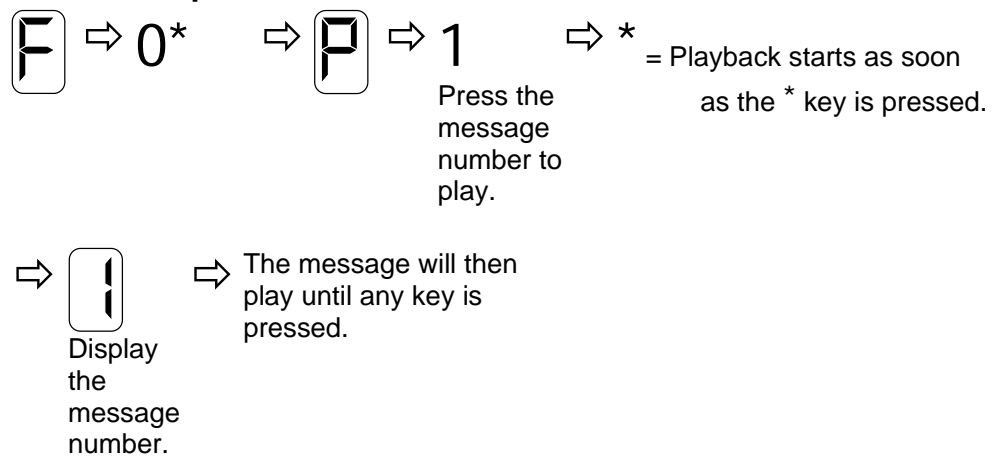

# PROGRAMMING – INPUT SPECIFIC PARAMETERS

## Function F10 Programming Your Pager Messages

When an alarm notification call is made to a Pager, the message in this function is sent.



If you want to use a text message, e.g. 'Boiler Alarm', this must be sent to an Alpha-numeric pager or cell phone. You need to use a PC and a terminal program such as HyperTerminal to configure alpha-numeric messages. See section 'Programming using RS232' in 'Application Notes' for detailed instructions.

---

**Notice to Australian Users:** The EDAC 400-02 is not compatible with SMS via TAP services in Australia. The 400-02 cannot send SMS messages to cellular phones in Australia.

---

Message **one** is entered as follows:

 ⇒ 10 ⇒  ⇒ Enter pager message followed by a # to save  
e.g. 2234#

Default: Empty (Displays as 'E' for Empty)

Each of the four Input pager messages must be programmed separately as follows:

- Use **F10** for Input 1 pager message 1 as in the example above.
- Use **F20** for Input 2 pager message 2.
- Use **F30** for Input 3 pager message 3.
- Use **F40** for Input 4 pager message 4.

**To reset a pager message to empty:** Select the message, do not enter a message and save using the # key.

## Function F11 Programming Your Telephone/Pager/SMS Numbers

The EDAC 400-02 can be programmed with up to 16 different phone numbers. Each of the four individual Inputs can have up to 4 phone numbers, associated with it hence a total of 16 numbers can be programmed into the EDAC 400-02.

---

**Notice to Australian Users:** The EDAC 400-02 is not compatible with SMS via TAP services in Australia. The 400-02 cannot send SMS messages to cellular phones in Australia.

---

By default the programmed numbers are treated as a single list of 16 numbers. Using function **F07 Call List Priority**, the list can be divided up and treated differently depending on the alarm Input trigger number. See function **F07**

When the alarm Input is activated, the EDAC 400-02 will start to dial through the call list, always starting with the first phone number on the call list, then the next and so on. When programming phone numbers and/or pager numbers they may be entered in any order. However, alarm notification calls will be made in the function sequence number in the table below while applying the rule selected in function **F07 Call List Priority**.

Slot #	Function
1	<b>F11</b>
2	<b>F12</b>
3	<b>F13</b>
4	<b>F14</b>

} Roster / Input 1

5	<b>F21</b>	} Roster / Input 2
6	<b>F22</b>	
7	<b>F23</b>	
8	<b>F24</b>	
9	<b>F31</b>	} Roster / Input 3
10	<b>F32</b>	
11	<b>F33</b>	
12	<b>F34</b>	
13	<b>F41</b>	} Roster / Input 4
14	<b>F42</b>	
15	<b>F43</b>	
16	<b>F44</b>	

When using pagers, the RIC code of the pager which is normally written on the pager, should be entered into one of these phone number slots.

**If you are using a PABX:** Sometimes problems can be encountered when getting the EDAC 400-02 to dial an outside line. Usually this occurs when the **outside line number** (e.g. 1 or 9) is dialled and the EDAC 400-02 begins dialling the phone number **before** the PABX can produce the outside line dial tone. This results in the first few numbers being missed by the PABX. This problem can be overcome by putting more pauses between the outside line number and the phone number to be dialled. If you are using a PABX system, a two-second pause may be inserted using the \* key. You cannot start or end with a pause.

⇒ **F** ⇒ 11 ⇒ **P** ⇒ Enter number followed by a # to save  
 e.g.  
**1\*02432#** (1 to get an outside line,  
 \* pause, 02432)  
 Then...

⇒ **E** ⇒ Enter the **call type** (see *Call Types* on page 32)  
 e.g.  
**1**  
 The number is then displayed for checking.

### Call Types

The 'call type' selects the type of call being made by the EDAC 400-02 to the user e.g. voice or pager. It also sets an option for how the alarm notification call associated with this number will be cancelled / acknowledged.

0	Voice call	Cancel not allowed
1	Voice call	Cancel by any number key
2	Voice call	Cancel by PIN
8	Numeric pager	Timed call using function <b>F54</b>
9	SMS/alphanumeric pager	Call using function <b>F15</b> and modem connection (speaker must be muted when using this function)
#	Numeric pager	Call progress detection

Each subsequent phone number to be dialled is entered in the same manner: **12** is list one, phone number two, **21** is list 2, phone number one or phone number five, if **F07** is on default setting of 5, providing one call list of 16 numbers (see table previous page).

### Clearing a Telephone Number:

Enter the function number then press the # key without a number. An 'E' will be displayed to show it is empty. To clear the complete list for one Input use #1 (call list for Input 1), #2 (call list for Input 2) #3 (call list for Input 3) or #4 (call list for Input 4).

---

**NOTE:** *If the memory jumper (J702) is in the **Protect** position, any new parameters you enter, such as phone numbers, will not be stored. This error can be easily detected by watching the numbers being played back for verification. The character display will show either an 'E', for empty, or the previous numbers will be displayed rather than the newly entered ones. See Jumper Settings in the Installation section of the manual for information on jumper settings.*

---

### Points to Note:

- You select a call type when you program each individual phone number. This provides the flexibility for some phone numbers being set to 'cancel by any key' and some being set to 'cancel by PIN' e.g. if the EDAC 400-02 is going to make an alarm notification call which could be received by the wrong person (such as a baby sitter), you might like to set this number to cancel by PIN to ensure any alarms do not get accidentally cancelled by the wrong person.
- Cancel methods shown here apply only to outgoing alarm notification calls made by the EDAC 400-02 to a human operator **not** incoming calls. See **F03 Cancel Option When Making an Incoming Call** for this.

### Function F15 Programming an SMS/Paging Access Number

This only applies to **SMS or Alpha-Numeric paging** that uses the TAP protocol. Your local dealer should be able to provide this number for the type of pager you are using. Most mobile phones can also use Alpha-Numeric paging to receive text onto the phone. This service is called short message service (SMS) or text messaging.

---

**Notice to Australian Users:** *The EDAC 400-02 is not compatible with SMS via TAP services in Australia. The 400-02 cannot send SMS messages to cell phones in Australia.*

---

**If you are using a PABX:** Sometimes problems can be encountered when getting the EDAC 400-02 to dial an outside line. Usually this occurs when the **outside line number** (e.g. 1 or 9) is dialled and the EDAC 400-02 begins dialling the pager number **before** the PABX can produce the outside line dial tone. This results in the first few numbers being missed by the PABX. This problem can be overcome by putting more pauses between the outside line number and the pager number to be dialled. If you are using a PABX system, A two-second pause may be inserted using the \* key. You cannot start or end with a pause.

The pager access number is entered as follows:

 Enter pager access number followed by a # to save  
e.g. 1\*026124#  
dials 1, pause, 026124

Default: Blank (Displays as 'E' for Empty)



Each of the four inputs must be programmed separately as follows:

- Use **F15** for Input 1, as in the example above.
- Use **F25** for Input 2.
- Use **F35** for Input 3.
- Use **F45** for Input 4.

## Function F51 Setting Inputs to Trigger or Report

An Input may be configured as triggering or reporting. A triggering input triggers alarm notification calls. A reporting input will not cause the EDAC 400-02 to make any calls. A reporting input will speak its message either when the EDAC 400-02 has already been triggered by another Input and is making an alarm notification call, or when you call into the unit to check its status (active, cancelled or idle).

Set Input **one** as follows:

  $\Rightarrow$  51  $\Rightarrow$    $\Rightarrow$  0 = Triggering input. This input dials.

1 = Reporting input.

When another input is dialling this input reports. This input will not cause the EDAC 400-02 to make any calls.

Default: 0 (Triggering)

By default all four inputs are set to triggering. Each of the four inputs must be programmed separately to change them from triggering to reporting, as follows:

- Use **F51** for Input 1, as in the example above.
- Use **F61** for Input 2.
- Use **F71** for Input 3.
- Use **F81** for Input 4.

## Function F52 Physical Input Trigger Configuration

You can configure the input to trigger on **normally open** (N.O.) or **normally closed** (N.C.) contacts. The pull-ups may be changed to pull-downs by moving the appropriate input channel jumper (see *Jumper Settings* in the *Installation* section). Any unused inputs must be treated as normally open.

The EDAC 400-02 can **latch** an input so that, even though the physical trigger is removed or gone back to its normal state, the EDAC 400-02 continues to make alarm notification calls. The input latches after the latch time as defined in function **F09**. Function **F96** determines how the time in function **F09** is applied and in what units (seconds or minutes).

By default the input triggers are set up to be **non-latching**. This means that when the input trigger is removed, the EDAC 400-02 will stop making alarm notification calls.

By default the input is set up for **normally open**. Connecting the input terminal to negative supply will trigger the EDAC 400-02.

Alternatively the input can be set up for **normally closed**, input terminal connected to negative supply. Opening the connection will trigger the EDAC 400-02.

The trigger type for input **one** is set as follows:

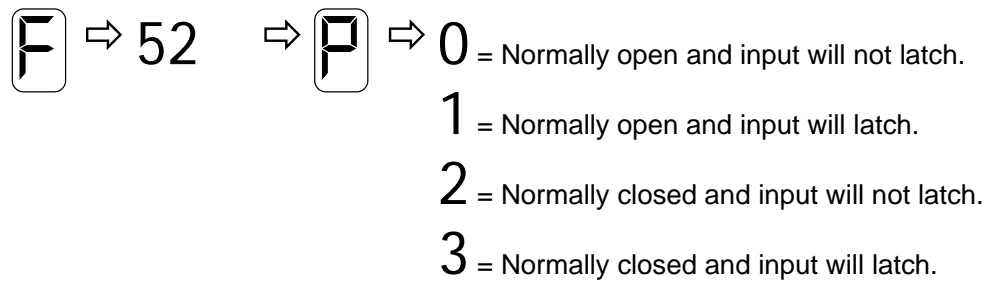

Default: 0 (Normally open)

By default all four inputs are set to Normally Open and the inputs will not latch. Each of the four inputs must be programmed separately to change them from N.O. non-latching as follows:

- Use **F52** for Input 1, as in the example above.
- Use **F62** for Input 2.
- Use **F72** for Input 3.
- Use **F82** for Input 4.

### **Function F53 Wait Time Between Calls**

This function determines the period to wait between one call and the next. The wait time allows an opportunity for the user to call into the EDAC 400-02 to cancel the input or listen to the current status messages. Each individual input has its own wait time.

Set the wait time for input **one** as follows:

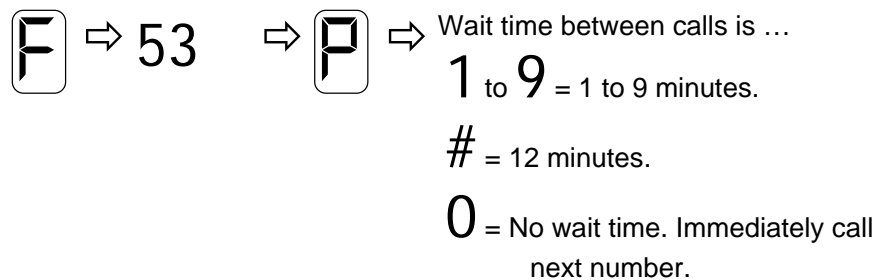

Default: 4 (Four minutes)

Each of the four inputs must be programmed separately as follows:

- Use **F53** for Input 1, as in the example above.
- Use **F63** for Input 2.
- Use **F73** for Input 3.
- Use **F83** for Input 4.

## Function F54 Pager Delay Time

The pager delay time only relates to numeric pager calls (see function **F11**). This is the time from dialling the number to when the paging network answers the call. The EDAC 400-02 sends the DTMF pager message at this point. You can determine this time by dialling the pager network with a telephone and measuring the period from dialling the number until the call is answered.

The pager delay time for input **one** is set as follows:

<b>F</b>	⇒	54	⇒	<b>P</b>	⇒	Pager delay time is ...
						<b>1</b> = 3 seconds
						<b>2</b> = 6 seconds
						<b>3</b> = 9 seconds
						<b>4</b> = 12 seconds
						<b>5</b> = 15 seconds
						<b>6</b> = 18 seconds
						<b>7</b> = 21 seconds
						<b>8</b> = 24 seconds
						<b>9</b> = 27 seconds
						<b>#</b> = 36 seconds

Default: 3 (Nine seconds)

Each of the four inputs must be programmed separately as follows:

- Use **F54** for Input **1**, as in the example above.
- Use **F64** for Input **2**.
- Use **F74** for Input **3**.
- Use **F84** for Input **4**.

## Function F55 Message Play Time

The Message Play Time is the amount of time, in minutes, that the EDAC 400-02 is allowed to be off hook to dial the number, speak messages and accept a cancellation. The EDAC 400-02 will speak the message for the playtime before the call is terminated. The play time starts from when the EDAC 400-02 starts to dial.

Note that if an alarm notification call is not answered and is forwarded through to a voicemail service the time programmed into this function will also determine the length of the message left on the answering service.

The playtime for input **one** is set as follows:

<b>F</b>	⇒	55	⇒	<b>P</b>	⇒	Play time is ...
						<b>1</b> to <b>9</b> = 1 to 9 minutes
						<b>#</b> = 12 minutes
						<b>0</b> = 30 sec

Default: 1 (One minute)

Each of the four inputs must be programmed separately as follows:

- Use **F55** for Input **1**, as in the example above.
- Use **F65** for Input **2**.
- Use **F75** for Input **3**.
- Use **F85** for Input **4**.

## Function F56 Call Counter

As successful telephone/pager calls are made they are counted. The input alarm condition is automatically self cancelled when the number of calls made exceeds the value set in this function. If a call was not successful (e.g. the telephone was BUSY) the call is not counted. Each input has its own call counter. An individual inputs call counter is incremented when the input message is spoken.

The call counter for input **one** is set as follows:

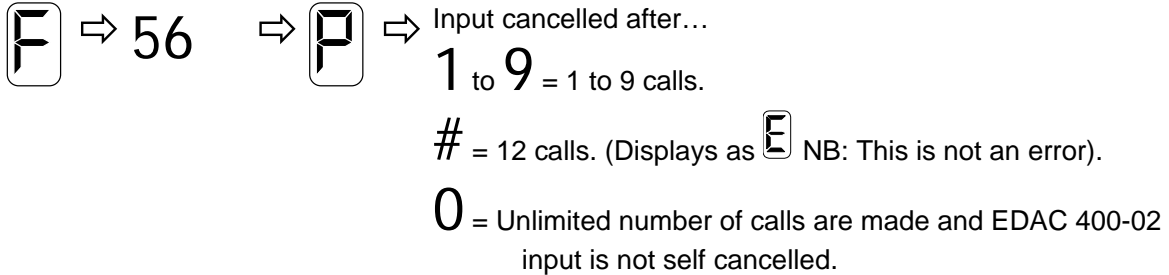

Default: 0 (Unlimited number of calls made)

Each of the four inputs must be programmed separately as follows:

- Use **F56** for Input 1, as in the example above.
- Use **F66** for Input 2.
- Use **F76** for Input 3.
- Use **F86** for Input 4.



---

**Automatic re-attempts to the same number:** *There shall be no more than 10 call attempts to the same number within any 30 minute period. To facilitate this, users and installers must set values of between 1 and 10 into the programming functions F56, F66, F76 and F86.*

---

## Function F57 SMS/Paging Service Password

The paging service in function **F15** may require a password. The password can only be entered via the RS232 port using Hyper Terminal. See section 'Programming using RS232' in 'Application Notes'.

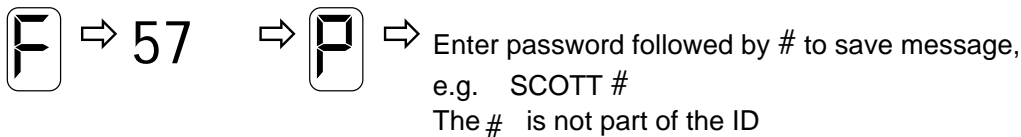

Default: Empty (Displays as an 'E', NB: This is not an error)

Each of the four inputs must be programmed separately as follows:

- Use **F57** for Input 1, as in the example above.
- Use **F67** for Input 2.
- Use **F77** for Input 3.
- Use **F87** for Input 4.

---

**Notice to Australian Users:** *The EDAC 400-02 is not compatible with SMS via TAP services in Australia. The 400-02 cannot send SMS messages to cellular phones in Australia.*

---

## Function F58 SMS/Paging Service ID

The paging service in function **F15** may require an ID. The ID can only be entered via the RS232 port.



The # is not part of the ID

Default: PG1

Each of the four inputs must be programmed separately as follows:

- Use **F58** for Input 1, as in the example above.
- Use **F68** for Input 2.
- Use **F78** for Input 3.
- Use **F88** for Input 4.

---

**Notice to Australian Users:** The EDAC 400-02 is not compatible with SMS via TAP services in Australia. The 400-02 cannot send SMS messages to cellular phones in Australia.

---

# PROGRAMMING – JUMPER SETTINGS

Below is a table detailing the hardware jumpers on the EDAC 400-02. This is followed by a circuit board overlay, which details where the jumpers are located on the EDAC 400-02.

**NOTE:** If the memory or voice protection jumpers (J702 and J602) are in the **Protect** position, any new parameters you enter, such as phone numbers, will not be stored. This error can be easily detected by watching the numbers being played back for verification. The character display will show either an 'E', for empty, or the previous numbers will be displayed rather than the newly entered ones.

	Function	Position/Mode		
J404	Input 1 Mode	Center = Pullup(Default)	Up = Pulldown	Down = Floating
J405	Input 2 Mode	Center = Pullup(Default)	Up = Pulldown	Down = Floating
J406	Input 3 Mode	Center = Pullup(Default)	Up = Pulldown	Down = Floating
J407	Input 4 Mode	Center = Pullup(Default)	Up = Pulldown	Down = Floating
J409	Direction 1/4	Down = Input 1 (Default)		Up = Output 4
J410	Direction 2/3	Down = Input 2 (Default)		Up = Output 3
J411	Direction 3/2	Down = Input 3 (Default)		Up = Output 2
J412	Direction 4/1	Down = Input 4 (Default)		Up = Output 1
J600	Speaker Mode	Up = Active (Default)		Down = Muted
J601	External Audio Input	Must be fitted to record voice using onboard microphone		
J602	Voice Message	Down = Open (Default)		Up = Protect
J702	Phone number & Parameters	Down = Open (Default)		Up = Protect

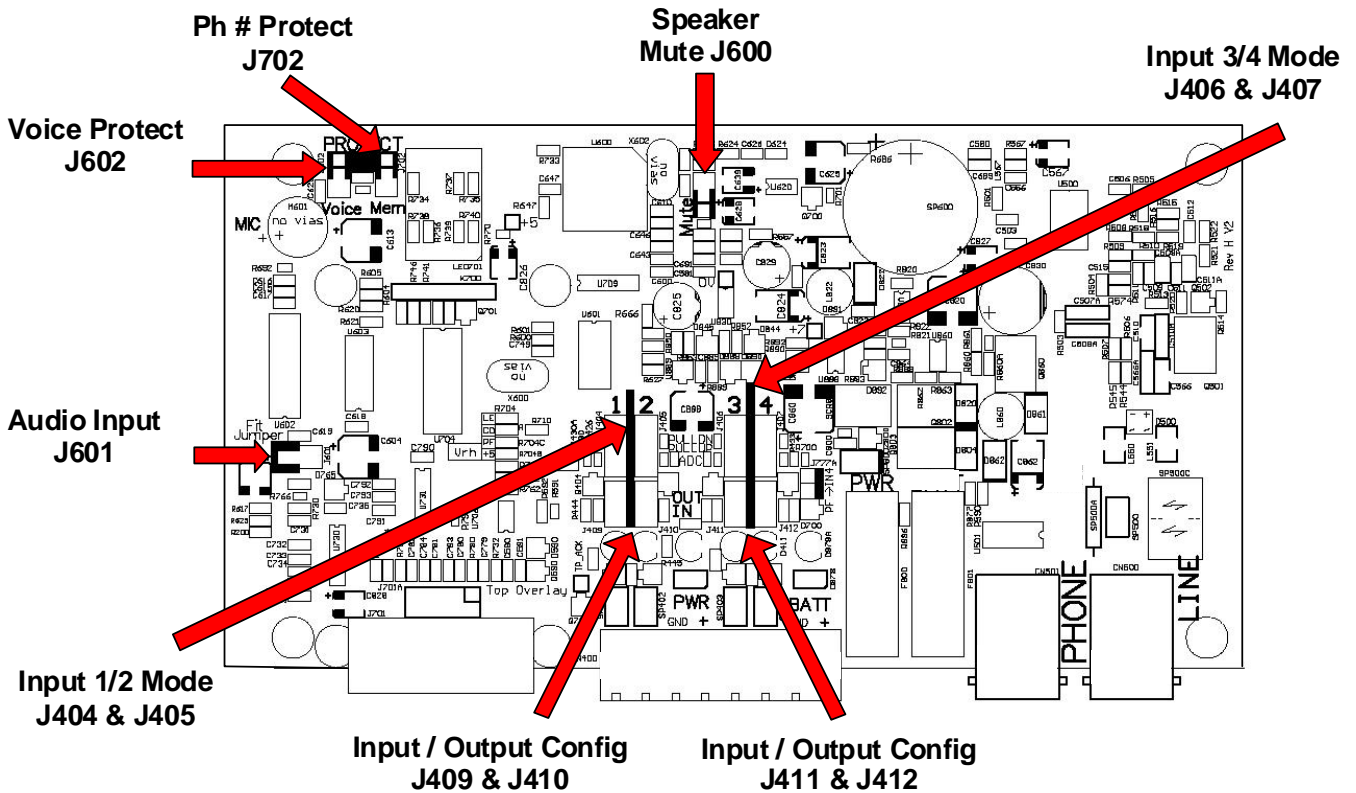

## APPLICATION NOTES

---

### *Using Outputs*

Each input can be used as a grounding Output. To toggle an Output you must call the EDAC 400-02 when it is in idle mode, i.e. all inputs have been cancelled or there are no active inputs. Once the EDAC 400-02 has answered, the idle message is spoken twice. Enter Output mode by pressing the PIN while the Site message is being played.

The Output mode message will speak along with each Output message (either off or on). The Output on message is spoken when the Output is grounded.

Pressing 1, 2, 3, or 4 toggles the state of Outputs 1, 2, 3 or 4 respectively. Output 1 is Input 4 and uses Input 4's voice message as an on message. Outputs 4, 3, 2, 1 are designated Input 1, 2, 3 and 4 respectively. Please refer to the table below to see which Outputs correspond to which inputs.

Input 1	Output 4
Input 2	Output 3
Input 3	Output 2
Input 4	Output 1

If no key press is detected for 15 seconds the EDAC 400-02 will terminate the call.  
# will also terminate the call.

The EDAC 400-02 will only react to Outputs that have been enabled (see function **F08**).  
Functions **F05 Answer Incoming Calls When all Inputs are Cancelled**, **F06 Answer Incoming Calls When no Inputs active**, and function **F08 Outputs**, must be configured appropriately.

---

**NOTE:** *All Outputs return to off when the power is removed.*

---

## Using Paging

### Numeric Pager

The most basic form of paging is to use a numeric pager. This type of pager can only display numbers or codes. When making an alarm notification call to a numeric pager you must enter the RIC code of the pager into a suitable phone number slot (see function **F11**), and select a call type. The call type will either be **Call Type 8** (timed call using function **F54**) or **Call Type #** (call progress detection).

**Please Note: If you are using a PABX, you will need to add the access code for an outside line and a pause.**

- **Timed Call Using F54 Pager Delay time**

This is the time from dialling the number to when the paging network answers the call. The EDAC 400-02 sends the DTMF pager message at this point. You can determine this time by dialling the pager network with a telephone and measuring the period from dialling the number until the call is answered.

- **F02 Call Progress Detection**

When using this setting, the dialler will attempt to detect the status of the call and send the pager message in **F10** at the appropriate time. It is more common to use **Timed Call** using function **F54** (*Pager Delay Time*).

When using the EDAC 400-02 with a pager, you will need to set a wait time between calls (function **F53**) so that you can call into the EDAC 400-02 to cancel the alarm, stopping further calls from being made.

Use function **F04** to set the number of rings before answer for an incoming call when any input is active. Default is four rings before auto answer.

Use function **F03** to set cancellation options (Cancel by any key or PIN) for an incoming call to the EDAC 400-02. Default is Cancel by any key.

### Alpha-Numeric pager/Text messaging (SMS)

One of the options for making calls is to make the calls via an SMS/paging host computer. SMS/paging is only configurable on the EDAC 400-02 using Hyper Terminal. See 'Programming using RS232' in the 'Application Notes' section.

The EDAC 400-02 uses standard TAP protocol to connect and send SMS/Alphanumeric pages to the host network. The EDAC 400-02 does not use ETAP or Pacnet.

If you are going to use SMS messaging to a cell phone, you may also need to subscribe to an additional service for Telecom NZ 027 mobiles called "Mobile Note Direct". This service enables the individual cell phone to receive SMS text messages from the TAP host. If you are in New Zealand and have a GSM or '021' cell phone you will need to talk to the manufacture for up-to-date information on where to go to arrange access to a TAP host.

---

**Notice to Australian Users:** *The EDAC 400-02 is not compatible with SMS via TAP services in Australia. The 400-02 cannot send SMS messages to cellular phones in Australia.*

---

You should contact your Telecommunications service provider regarding host access numbers, IDs, passwords and subscriptions.

---

**NOTE:** *Some Paging networks charge an access fee.*

---

- **Alpha-Numeric Pager RIC codes**

When making an alarm notification call to an Alpha-Numeric pager you must enter the RIC code of the pager into a suitable phone number slot (see function **F11**), followed by #9 (call type 9 for SMS/Alphanumeric paging).

With Alpha-Numeric paging (call type **9**) only the pager number is entered. **Do not** enter the access code. For example, pager RIC 026-1234-567 is entered as 1234567.

If you are using a PABX, you **do not** need to add an access code for an outside line and a pause. This is done when the host service number is dialled, see below.

- **Entering cell phone numbers for SMS/Text messaging**

If you want to use SMS, you will enter a cell phone number into a suitable phone number slot (See function **F11**) followed by #9.

If you are using a PABX, you **do not** need to add an access code for an outside line and a pause. This is done when the host service number is dialled, see below.

The following table provides the information required for use in New Zealand with Telecom 025/027 cell phones.

Cell phones starting with:	
027....	Enter as is, including 027
025...Plus 7 digit number	5301.....drop off 1st digit of 7 digit number
025...Plus 6 digit number	5300...rest of 6 digit number

- **Setting up the SMS/Paging host**

To call the SMS/paging host you need to enter the host telephone number (see function **F15**). The host network requires a service ID (function **F58**) and password (function **F57**). Most SMS/paging host networks use the same ID and password as the default that is used in the EDAC 400-02.

The table below gives the information required for use in New Zealand.

Service Type	Service No	Service ID	Service PW	Service Speed
Alpha Paging	026,4001283	PG1		14400
Mobile Note (025)	026,199999	PG1	zmnote	14400
Vodafone (021)				

**Points to Note:**

- When using the EDAC 400-02 with a Alpha-Numeric pager or SMS, you will need to set a wait time between calls (function **F53**) so that you can call into the EDAC 400-02 to cancel the alarm, stopping further calls from being made.
- Use function **F04** to set the number of rings before answer for an incoming call when any input is active. Default is four rings before auto answer.
- Use function **F03** to set cancellation options (Cancel by any key or PIN) for an incoming call to the EDAC 400-02. Default is Cancel by any key.
- If the call to the host network is not successful the call is not counted by the call counter. The EDAC 400-02 will then move to the next number in the list.

## Modem Communications

The EDAC 400-02 has a 2400-baud V22bis modem, which can be used to communicate with external devices e.g. a data-logger or PLC plugged into the RS232 connector. A call to the EDAC 400-02 can be established with a PC using HyperTerminal, a Windows application shipped with all versions of Windows. When the call is made using **ATDT<phone number>,,,##** the EDAC 400-02 will go into **through mode** allowing direct RS232 communications between the PC and the external device connected to the EDAC 400-02.

## Programming Using RS232

Using HyperTerminal, a Windows application shipped with all versions of Windows, you can configure the EDAC 400-02 via its RS232 connector. This method is used if you require alphanumeric pager messages to be programmed.

Connect the EDAC 400-02 to a free serial port on a PC using a straight through serial cable. Start the HyperTerminal application, select the appropriate com port and click O.K. Configure with the following settings.

Bit per second	1200
Data bits	8
Parity	None
Stop bits	1
Flow Control	None

For programming through the RS232 interface, use the instructions as described in this manual but replace some of the symbols as follows:

For <b>F</b> you will see	>
For <b>#</b> use	<b>#</b> key or enter key
For <b>*</b> use	<b>*</b> key or , key

An = sign will appear before displaying the stored EEPROM contents.

## FREQUENTLY ASKED QUESTIONS

---

### ***“I’ve plugged the EDAC 400-02 in but nothing happens.”***

Check that the power supply you are using is 10-30V direct current (DC). Also check that the polarity of the supply is correct at the terminals of the EDAC 400-02. Check also for shorts and fractures in the cable supplying the power to the EDAC 400-02. A good indication is to connect a multimeter set to the DC volts range across the + and – terminals on the EDAC 400-02 to check that the correct input voltage is present. Also check that the onboard supply fuses are intact. These fuses are in place to protect the unit from power surges, short circuits and incorrect supply voltage polarity.



**WARNING:** *Fit only 500mA fuses to the EDAC 400-02 as fitting anything else could cause major damage to the unit and will void your warranty.*

### ***“The EDAC 400-02 will trigger but doesn’t make a call. What’s going wrong?”***

The most likely cause is that the EDAC 400-02 is not seeing dial tone. Listen to the speaker when the EDAC 400-02 is attempting to dial. If **you** cannot hear the dial tone then, neither can the EDAC 400-02. Check that you are using the line cord supplied with the product to connect the product to the wall socket, and that it is correctly connected at both ends.

When using a **PABX** system, problems can be encountered when getting the EDAC 400-02 to dial an outside line. Usually this occurs when the **outside line number** (e.g. 1 or 9) is dialled and the EDAC 400-02 begins dialling the phone number **before** the PABX can produce the outside line dial tone. This results in the first few numbers being missed by the PABX. This problem can be overcome by putting more pauses between the outside line number and the phone number to be dialled (see function **F11** to **F14 Programming Your Telephone/Pager/SMS Numbers**).

### ***“The EDAC 400-02 calls out O.K. but I don’t get the call.”***

Check that the phone numbers programmed into the EDAC 400-02 *are* the ones that you want it to call (see function **F11** to **F14 Programming Your Telephone/Pager/SMS Numbers**). Also check that the **call type** is correct i.e. you have set the EDAC 400-02 to call a telephone **or** a pager.

### ***“The EDAC 400-02 is set up to call my cell phone. If I’m out of range or my phone is switched off will I get charged for all the calls the EDAC 400-02 makes but I don’t get?”***

Yes you will. Care is advised when configuring the EDAC 400-02 to call a cell phone. It is strongly advised to put a limit on the number of calls the EDAC 400-02 can make. Use function **F56 Call Counters**, so that if your cell phone is out of range or switched off, the EDAC 400-02 won’t make continuous calls, which you will get charged for.

### ***“The EDAC 400-02 won’t let me record any voice messages, or enter any new programming commands, why not?”***

The EDAC 400-02 has two jumpers on the circuit board, which can be positioned to stop accidental changes being made to the unit’s configuration and voice messages. If the memory or voice protection jumpers (J702 and J602) are in the **protect** position, any new parameters you enter, such as phone numbers, will not be stored. This error can be easily detected by watching the numbers being played back for verification. The character display will either show an ‘E’ for empty, or the previous numbers will be displayed rather than the newly entered ones. See *Jumper Settings* in the *Specifications* section of the manual for information on jumper settings.

### ***“The EDAC 400-02 is constantly making calls, even when there is no alarm condition. What’s going wrong?”***

Check that the setting in function **F52 Physical Input Trigger Configuration** is set correctly for the type of input trigger you are using. Remember that **normally open** means the EDAC 400-02 will trigger when the contact closes and that **normally closed** means that the EDAC 400-02 will trigger when the contact is opened. Also check the condition of the input switches/sensors and ensure they are operating correctly.

## COMPLIANCE NOTES

---

### NOTICE TO AUSTRALIAN USERS

The ACA requires all equipment to comply with the automatic redialling rate and number limits as stated in its Technical Standards. An automatic redial is two or more call attempts to the same telephone number, which are not initiated by a person.

The automatic redialling limits required by the ACA are:

1. BUSY tone detection enabled – not more than 10 calls to the same number for any trigger occurrence until a space of 30 minutes has elapsed.
2. BUSY signal detection disabled – not more than three calls to the same number for any trigger occurrence until a space of 30 minutes has elapsed.
3. The time between calls to the same number should not be set to less than 30 seconds.
4. If the dial tone detect is disabled (function **F02 Call Progress**) then the device must not make more than three call attempts to the same number (see function **F56 Call Counter**).

You must ensure that your equipment settings do not exceed the above limits. Failure to set the equipment to these values will result in the equipment being operated in a non-compliant manner.

### NOTICE TO NEW ZEALAND USERS

The grant of a Telepermit for any item of terminal equipment indicates only that Telecom has accepted that the item complies with minimum conditions for connection to its network. It indicates no endorsement of the product by Telecom, nor does it provide any sort of warranty. Above all, it provides no assurance that any item will work correctly in all respects with another item of Telepermitted equipment of a different make or model, nor does it imply that any product is compatible with all of Telecom's network services.

#### **Compliance Notes**

- This device may be subject to ringing or bell tinkle when certain other devices are connected to the same line. If this occurs, the problem should not be referred to the Telecom Faults Service.
- This device only responds to Distinctive Alert cadences DA1 and DA2. This means that the EDAC 222-02 will not respond to 'faxability' ring.

Some parameters required for compliance with Telecom's Telepermit requirements are dependent on the equipment configuration and/or settings. In order to operate within the limits for compliance with Telecom's specifications, the equipment shall be set to ensure that:

- There shall be no more than 10 call attempts to the same number within any 30 minute period. To facilitate this, users and installers must set values of between 1 and 10 into the programming functions F56, F66, F76 and F86.
- This equipment should not be used under any circumstances that may constitute a nuisance to other Telecom customers.
- This equipment shall not be set up to make automatic calls to Telecom's 111 Emergency Service.
- Telepermitted equipment only may be connected to the auxiliary telephone port. The auxiliary telephone port is not specifically designed for 3-wire connected equipment that may not respond to incoming ringing when attached to this port.

## **GLOSSARY**

---

### **Acknowledged or cancelled**

When the EDAC 400-02 is active (in alarm state) the unit will make alarm notification calls. When these active trigger states (inputs) have all been acknowledged the EDAC 400-02 is said to be in a cancelled state. This means that the EDAC 400-02 will not make any further calls. The input is still present however and it must be removed in order to re-trigger the EDAC 400-02.

### **Active**

The EDAC 400-02 is active when an input has been triggered. This will cause the unit to make alarm notification calls.

### **Alpha-Numeric pager**

This is a pager that can display messages with words in them e.g. 'Boiler 2 alarm'.

### **Cancelled or acknowledged**

When the EDAC 400-02 is active (i.e. an input has been triggered) the unit will make alarm notification calls. Once these inputs have all been acknowledged the EDAC 400-02 is said to be in a cancelled state. This means that the EDAC 400-02 will not make any further calls. The input is still present however and it must be removed in order to re-trigger the EDAC 400-02. Any new trigger on a different alarm input will initiate a new alarm notification call sequence.

### **Cleared or idle**

The input is cleared when it no longer meets the input criterion e.g. trigger on close contact and the contact is open. The EDAC 400-02 is idle when all inputs are clear (i.e. no inputs present).

### **Idle**

When the EDAC 400-02 is not acting on any input it is said to be idle, normal or in RUN mode.

### **Input**

The input is the physical event that triggers the EDAC 400-02 to make alarm notification calls. Outputs control external devices whereas inputs trigger the EDAC 400-02.

### **Latching**

Once triggered, the input will remain in the alarmed state until acknowledged by the operator, regardless of the physical input going back to its normal state.

### **Normally Closed (N.C)**

Opening the connection between the input and Gnd will trigger the dialler.

### **Normally Open (N.O)**

Connecting the input to Gnd will Close the connection, and trigger the dialler.

### **Numeric Pager**

Pager that can only display numbers or codes

### **Output**

The EDAC 400-02 has four Outputs. The four inputs can be changed to be Outputs and therefore allow control of external devices by the EDAC 400-02. Moving jumpers on the EDAC 400-02 and setting function F08 allows an input to act as an Output. When the EDAC 400-02 is in idle mode and a call into the EDAC 400-02 is made, the EDAC 400-02 can be placed in Output mode where the current Output states are reported and can be toggled.

### **Parameter**

A value that must be entered by the user, such as a PIN number or phone number.

### **SMS**

Short Message service, used for sending text messages to cell phones

### **Trigger**

When the input criterion is exceeded (e.g. trigger on close contact) the EDAC 400-02 is triggered and will proceed to make calls until the EDAC 400-02 is either cancelled or cleared.

## WARRANTY

---

EDAC Electronics Limited ("EDAC") warrants its equipment against defects in materials or workmanship. The term of this warranty shall be as stated in the Contract of Sale for such equipment. Absent any such statement in the Contract of Sale, the term of this warranty shall be one year from the date of initial sale. This warranty only applies to the original purchaser. It does not apply to pre-used equipment.

This warranty is void in any of the following circumstances: (a) The equipment has been misused, neglected, damaged or abused. (b) The equipment has been improperly installed, operated, repaired or maintained. (c) The equipment has been modified. (d) The equipment has been connected to other equipment with which it is not compatible. (e) The equipment has been stored in conditions outside its electrical or environmental specifications. (f) The equipment has been used for purposes other than for which it was designed. (g) The equipment has been used outside its stated specifications and operating parameters.

Unless otherwise provided in a contract of sale, correct installation is the owner's responsibility. EDAC shall not be liable if the equipment has been altered, damaged or rendered non-functional through incorrect installation.

EDAC does not warrant any modules or components manufactured by third parties. However, EDAC shall extend to the owner, in so far as practicable, the benefit of any warranties that such third party manufacturers may have given to EDAC concerning such modules and components.

To assert a warranty claim, complete EDAC's Return Materials Authorisation form ("RMA form"). An RMA form is available from EDAC or its authorised service agent. If EDAC accepts the warranty claim, it shall instruct the owner to return the equipment either to EDAC or its authorised service agent. Wherever possible, use the original packaging to return items. EDAC may request proof of purchase.

If EDAC accepts the warranty claim, EDAC will provide, or arrange for, service, repair or replacement as EDAC shall determine in its sole discretion. EDAC shall bear the cost of such service, repair or replacement. The owner shall bear the cost of freight and insurance on the equipment to EDAC or its authorised service agent, as the case may be. EDAC shall bear the cost of freight and insurance to return the equipment to the owner.

EDAC's sole responsibility is to repair, replace or service equipment subject to a valid warranty claim. Under no circumstance will EDAC be liable for direct, indirect, incidental, special or consequential costs or damages, including dismantling and re-installation costs, loss of operations or profits, to the maximum extent permitted by law.

EDAC accepts no liability for personal injury or property damage resulting from failure to heed relevant operating and safety procedures specified by EDAC or imposed by law.

This is an express warranty. EDAC disclaims any other express or implied warranties, including warranties of merchantability or fitness for purpose, to the maximum extent permitted by law.

Some jurisdictions do not allow limitations or disclaimers of implied or statutory warranties. Some jurisdictions do not allow disclaimers or exclusions of consequential or incidental damages. Therefore, the above disclaimers, limitations and exclusions may not apply in all jurisdictions in which EDAC sells its equipment.

This warranty gives the owner specific legal rights. The owner may have other rights or remedies pursuant to the laws in its territory. Nothing in this limited warranty should be construed as limiting or restricting any other statutory right or remedy of the owner, except for such limitations or restrictions herein as may be allowed by the law of the territory.

EDAC has a policy of continual product improvement and specifications are subject to change without notice.

## INTERNATIONAL CONTACT DETAILS

---

### Australia

EDAC Electronics Aust Pty Ltd  
Suite 6, 173 Boronia Rd  
Boronia  
Vic. 3155  
Australia

Telephone: +61 3 9762-6244  
Facsimile: +61 3 9762-6255  
Email: [sales@edac.com.au](mailto:sales@edac.com.au)  
Web: <http://www.edac.com.au/>

### New Zealand

EDAC Electronics Ltd  
47 Mandeville Street  
P.O. Box 80033  
Riccarton  
Christchurch 8011  
New Zealand

Telephone: +64 3 341-5166  
Facsimile: +64 3 341-5176  
Email: [sales@edacelectronics.com](mailto:sales@edacelectronics.com)  
Web: [www.edacelectronics.com](http://www.edacelectronics.com)